

Lessons In Electric Circuits
Volume V – Reference

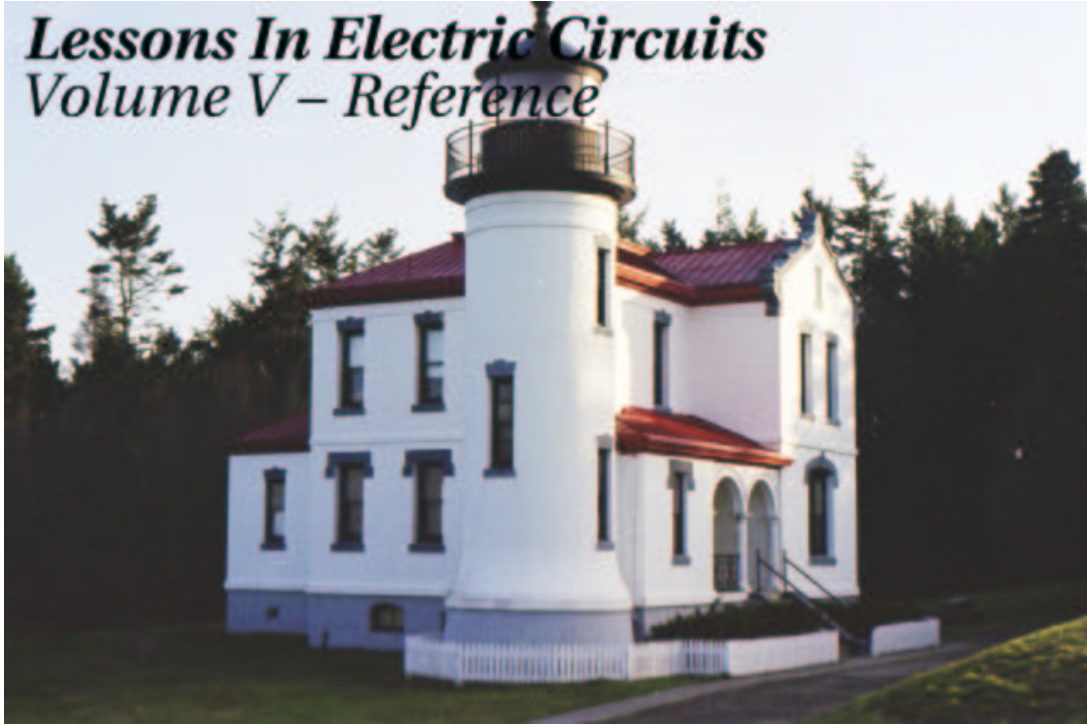

Fourth Edition, last update June 29, 2002

Lessons In Electric Circuits, Volume V – Reference

By Tony R. Kuphaldt

Fourth Edition, last update June 29, 2002

© 2000-2002, Tony R. Kuphaldt

This book is published under the terms and conditions of the Design Science License. These terms and conditions allow for free copying, distribution, and/or modification of this document by the general public. The full Design Science License text is included in the last chapter.

As an open and collaboratively developed text, this book is distributed in the hope that it will be useful, but WITHOUT ANY WARRANTY; without even the implied warranty of MERCHANTABILITY or FITNESS FOR A PARTICULAR PURPOSE. See the Design Science License for more details.

PRINTING HISTORY

- First Edition: Printed in June of 2000. Plain-ASCII illustrations for universal computer readability.
- Second Edition: Printed in September of 2000. Illustrations reworked in standard graphic (eps and jpeg) format. Source files translated to *Texinfo* format for easy online and printed publication.
- Third Edition: Equations and tables reworked as graphic images rather than plain-ASCII text.
- Fourth Edition: Printed in XXX 2001. Source files translated to *SubML* format. SubML is a simple markup language designed to easily convert to other markups like L^AT_EX, HTML, or DocBook using nothing but search-and-replace substitutions.

Contents

1	USEFUL EQUATIONS AND CONVERSION FACTORS	1
1.1	DC circuit equations and laws	1
1.1.1	Ohm's and Joule's Laws	1
1.1.2	Kirchhoff's Laws	2
1.2	Series circuit rules	2
1.3	Parallel circuit rules	2
1.4	Series and parallel component equivalent values	2
1.4.1	Series and parallel resistances	2
1.4.2	Series and parallel inductances	3
1.4.3	Series and Parallel Capacitances	3
1.5	Capacitor sizing equation	3
1.6	Inductor sizing equation	4
1.7	Time constant equations	4
1.7.1	Value of time constant in series RC and RL circuits	4
1.7.2	Calculating voltage or current at specified time	4
1.7.3	Calculating time at specified voltage or current	5
1.8	AC circuit equations	5
1.8.1	Inductive reactance	5
1.8.2	Capacitive reactance	5
1.8.3	Impedance in relation to R and X	5
1.8.4	Ohm's Law for AC	6
1.8.5	Series and Parallel Impedances	6
1.8.6	Resonance	6
1.8.7	AC power	7
1.9	Decibels	7
1.10	Metric prefixes and unit conversions	8
1.11	Data	11
2	RESISTOR COLOR CODES	13
2.1	Example #1	14
2.2	Example #2	14
2.3	Example #3	14
2.4	Example #4	15
2.5	Example #5	15

2.6	Example #6	15
3	CONDUCTOR AND INSULATOR TABLES	17
3.1	Copper wire gage table	17
3.2	Copper wire ampacity table	18
3.3	Coefficients of specific resistance	19
3.4	Temperature coefficients of resistance	19
3.5	Critical temperatures for superconductors	20
3.6	Dielectric strengths for insulators	20
3.7	Data	21
4	ALGEBRA REFERENCE	23
4.1	Basic identities	23
4.2	Arithmetic properties	23
4.2.1	The associative property	23
4.2.2	The commutative property	23
4.2.3	The distributive property	24
4.3	Properties of exponents	24
4.4	Radicals	24
4.4.1	Definition of a radical	24
4.4.2	Properties of radicals	24
4.5	Important constants	25
4.5.1	Euler's number	25
4.5.2	Pi	25
4.6	Logarithms	25
4.6.1	Definition of a logarithm	25
4.6.2	Properties of logarithms	26
4.7	Factoring equivalencies	26
4.8	The quadratic formula	27
4.9	Sequences	27
4.9.1	Arithmetic sequences	27
4.9.2	Geometric sequences	28
4.10	Factorials	28
4.10.1	Definition of a factorial	28
4.10.2	Strange factorials	28
4.11	Solving simultaneous equations	28
4.11.1	Substitution method	29
4.11.2	Addition method	33
5	TRIGONOMETRY REFERENCE	39
5.1	Right triangle trigonometry	39
5.1.1	Trigonometric identities	39
5.1.2	The Pythagorean theorem	40
5.2	Non-right triangle trigonometry	40
5.2.1	The Law of Sines (for <i>any</i> triangle)	40
5.2.2	The Law of Cosines (for <i>any</i> triangle)	40

5.3	Trigonometric equivalencies	41
5.4	Hyperbolic functions	41
6	CALCULUS REFERENCE	43
6.1	Rules for limits	43
6.2	Derivative of a constant	43
6.3	Common derivatives	44
6.4	Derivatives of power functions of e	44
6.5	Trigonometric derivatives	44
6.6	Rules for derivatives	45
6.6.1	Constant rule	45
6.6.2	Rule of sums	45
6.6.3	Rule of differences	45
6.6.4	Product rule	45
6.6.5	Quotient rule	45
6.6.6	Power rule	45
6.6.7	Functions of other functions	46
6.7	The antiderivative (Indefinite integral)	46
6.8	Common antiderivatives	47
6.9	Antiderivatives of power functions of e	47
6.10	Rules for antiderivatives	47
6.10.1	Constant rule	47
6.10.2	Rule of sums	47
6.10.3	Rule of differences	47
6.11	Definite integrals and the fundamental theorem of calculus	48
6.12	Differential equations	48
7	USING THE <i>SPICE</i> CIRCUIT SIMULATION PROGRAM	49
7.1	Introduction	49
7.2	History of SPICE	50
7.3	Fundamentals of SPICE programming	50
7.4	The command-line interface	55
7.5	Circuit components	56
7.5.1	Passive components	57
7.5.2	Active components	58
7.5.3	Sources	61
7.6	Analysis options	63
7.7	Quirks	66
7.7.1	A good beginning	66
7.7.2	A good ending	66
7.7.3	Must have a node 0	66
7.7.4	Avoid open circuits	67
7.7.5	Avoid certain component loops	67
7.7.6	Current measurement	71
7.7.7	Fourier analysis	74
7.8	Example circuits and netlists	74

7.8.1	Multiple-source DC resistor network, part 1	74
7.8.2	Multiple-source DC resistor network, part 2	75
7.8.3	RC time-constant circuit	76
7.8.4	Plotting and analyzing a simple AC sinewave voltage	77
7.8.5	Simple AC resistor-capacitor circuit	79
7.8.6	Low-pass filter	79
7.8.7	Multiple-source AC network	82
7.8.8	AC phase shift demonstration	83
7.8.9	Transformer circuit	84
7.8.10	Full-wave bridge rectifier	85
7.8.11	Common-base BJT transistor amplifier	87
7.8.12	Common-source JFET amplifier with self-bias	90
7.8.13	Inverting op-amp circuit	91
7.8.14	Noninverting op-amp circuit	94
7.8.15	Instrumentation amplifier	95
7.8.16	Op-amp integrator with sinewave input	96
7.8.17	Op-amp integrator with squarewave input	98
8	TROUBLESHOOTING – THEORY AND PRACTICE	101
8.1	101
8.2	Questions to ask before proceeding	102
8.3	General troubleshooting tips	102
8.3.1	Prior occurrence	103
8.3.2	Recent alterations	103
8.3.3	Function vs. non-function	103
8.3.4	Hypothesize	104
8.4	Specific troubleshooting techniques	104
8.4.1	Swap identical components	104
8.4.2	Remove parallel components	105
8.4.3	Divide system into sections and test those sections	106
8.4.4	Simplify and rebuild	107
8.4.5	Trap a signal	107
8.5	Likely failures in proven systems	108
8.5.1	Operator error	108
8.5.2	Bad wire connections	108
8.5.3	Power supply problems	109
8.5.4	Active components	109
8.5.5	Passive components	109
8.6	Likely failures in unproven systems	110
8.6.1	Wiring problems	110
8.6.2	Power supply problems	110
8.6.3	Defective components	110
8.6.4	Improper system configuration	111
8.6.5	Design error	111
8.7	Potential pitfalls	111
8.8	Contributors	113

9	CIRCUIT SCHEMATIC SYMBOLS	115
9.1	Wires and connections	115
9.2	Power sources	116
9.3	Resistors	117
9.4	Capacitors	117
9.5	Inductors	118
9.6	Mutual inductors	118
9.7	Switches, hand actuated	119
9.8	Switches, process actuated	120
9.9	Switches, electrically actuated (relays)	121
9.10	Connectors	121
9.11	Diodes	122
9.12	Transistors, bipolar	123
9.13	Transistors, junction field-effect (JFET)	123
9.14	Transistors, insulated-gate field-effect (IGFET or MOSFET)	124
9.15	Transistors, hybrid	124
9.16	Thyristors	125
9.17	Integrated circuits	126
9.18	Electron tubes	128
10	PERIODIC TABLE OF THE ELEMENTS	129
10.1	Table (landscape view)	130
10.2	Table (portrait view)	131
10.3	Data	131
11	ABOUT THIS BOOK	133
11.1	Purpose	133
11.2	The use of SPICE	134
11.3	Acknowledgements	135
12	CONTRIBUTOR LIST	137
12.1	How to contribute to this book	137
12.2	Credits	138
12.2.1	Alejandro Gamero Divasto	138
12.2.2	Tony R. Kuphaldt	138
12.2.3	Your name here	139
12.2.4	Typo corrections and other “minor” contributions	139
13	DESIGN SCIENCE LICENSE	141
13.1	0. Preamble	141
13.2	1. Definitions	141
13.3	2. Rights and copyright	142
13.4	3. Copying and distribution	142
13.5	4. Modification	143
13.6	5. No restrictions	143
13.7	6. Acceptance	143

13.8 7. No warranty	143
13.9 8. Disclaimer of liability	144

Chapter 1

USEFUL EQUATIONS AND CONVERSION FACTORS

1.1 DC circuit equations and laws

1.1.1 Ohm's and Joule's Laws

Ohm's Law

$$E = IR \quad I = \frac{E}{R} \quad R = \frac{E}{I}$$

Joule's Law

$$P = IE \quad P = \frac{E^2}{R} \quad P = I^2R$$

Where,

E = Voltage in volts

I = Current in amperes (amps)

R = Resistance in ohms

P = Power in watts

NOTE: the symbol "V" is sometimes used to represent voltage instead of "E". In some cases, an author or circuit designer may choose to exclusively use "V" for voltage, never using the symbol "E." Other times the two symbols are used interchangeably, or "E" is used to represent voltage from a power source while "V" is used to represent voltage across a load (voltage "drop").

1.1.2 Kirchhoff's Laws

"The algebraic sum of all voltages in a loop must equal zero."

Kirchhoff's Voltage Law (KVL)

"The algebraic sum of all currents entering and exiting a node must equal zero."

Kirchhoff's Current Law (KCL)

1.2 Series circuit rules

- Components in a series circuit share the same current. $I_{total} = I_1 = I_2 = \dots I_n$
- Total resistance in a series circuit is equal to the sum of the individual resistances, making it *greater* than any of the individual resistances. $R_{total} = R_1 + R_2 + \dots R_n$
- Total voltage in a series circuit is equal to the sum of the individual voltage drops. $E_{total} = E_1 + E_2 + \dots E_n$

1.3 Parallel circuit rules

- Components in a parallel circuit share the same voltage. $E_{total} = E_1 = E_2 = \dots E_n$
- Total resistance in a parallel circuit is *less* than any of the individual resistances. $R_{total} = 1 / (1/R_1 + 1/R_2 + \dots 1/R_n)$
- Total current in a parallel circuit is equal to the sum of the individual branch currents. $I_{total} = I_1 + I_2 + \dots I_n$

1.4 Series and parallel component equivalent values

1.4.1 Series and parallel resistances

Resistances

$$R_{series} = R_1 + R_2 + \dots R_n$$

$$R_{parallel} = \frac{1}{\frac{1}{R_1} + \frac{1}{R_2} + \dots \frac{1}{R_n}}$$

1.4.2 Series and parallel inductances

Inductances

$$L_{\text{series}} = L_1 + L_2 + \dots + L_n$$

$$L_{\text{parallel}} = \frac{1}{\frac{1}{L_1} + \frac{1}{L_2} + \dots + \frac{1}{L_n}}$$

Where,

L = Inductance in henrys

1.4.3 Series and Parallel Capacitances

Capacitances

$$C_{\text{series}} = \frac{1}{\frac{1}{C_1} + \frac{1}{C_2} + \dots + \frac{1}{C_n}}$$

$$C_{\text{parallel}} = C_1 + C_2 + \dots + C_n$$

Where,

C = Capacitance in farads

1.5 Capacitor sizing equation

$$C = \frac{\epsilon A}{d}$$

Where,

C = Capacitance in Farads

ϵ = Permittivity of dielectric (absolute, not relative)

A = Area of plate overlap in square meters

d = Distance between plates in meters

1.6 Inductor sizing equation

$$L = \frac{N^2 \mu A}{l}$$

Where,

L = Inductance of coil in Henrys

N = Number of turns in wire coil (straight wire = 1)

μ = Permeability of core material (absolute, not relative)

A = Area of coil in square meters

l = Average length of coil in meters

1.7 Time constant equations

1.7.1 Value of time constant in series RC and RL circuits

Time constant in seconds = RC

Time constant in seconds = L/R

1.7.2 Calculating voltage or current at specified time

Universal Time Constant Formula

$$\text{Change} = (\text{Final-Start}) \left(1 - \frac{1}{e^{t/\tau}} \right)$$

Where,

Final = Value of calculated variable after infinite time
(its *ultimate* value)

Start = Initial value of calculated variable

e = Euler's number (≈ 2.7182818)

t = Time in seconds

τ = Time constant for circuit in seconds

1.7.3 Calculating time at specified voltage or current

$$t = \tau \left(\ln \frac{1}{1 - \frac{\text{Change}}{\text{Final} - \text{Start}}} \right)$$

1.8 AC circuit equations**1.8.1 Inductive reactance**

$$X_L = 2\pi fL$$

Where,

X_L = Inductive reactance in ohms

f = Frequency in hertz

L = Inductance in henrys

1.8.2 Capacitive reactance

$$X_C = \frac{1}{2\pi fC}$$

Where,

X_C = Inductive reactance in ohms

f = Frequency in hertz

C = Capacitance in farads

1.8.3 Impedance in relation to R and X

$$Z_L = R + jX_L$$

$$Z_C = R - jX_C$$

1.8.4 Ohm's Law for AC

$$E = IZ \quad I = \frac{E}{Z} \quad Z = \frac{E}{I}$$

Where,

E = Voltage in volts

I = Current in amperes (amps)

Z = Impedance in ohms

1.8.5 Series and Parallel Impedances

$$Z_{\text{series}} = Z_1 + Z_2 + \dots + Z_n$$

$$Z_{\text{parallel}} = \frac{1}{\frac{1}{Z_1} + \frac{1}{Z_2} + \dots + \frac{1}{Z_n}}$$

NOTE: All impedances must be calculated in *complex* number form for these equations to work.

1.8.6 Resonance

$$f_{\text{resonant}} = \frac{1}{2\pi \sqrt{LC}}$$

NOTE: This equation applies to a non-resistive LC circuit. In circuits containing resistance as well as inductance and capacitance, this equation applies only to series configurations and to parallel configurations where R is very small.

1.8.7 AC power

$$P = \text{true power} \quad P = I^2 R \quad P = \frac{E^2}{R}$$

*Measured in units of **Watts***

$$Q = \text{reactive power} \quad Q = I^2 X \quad Q = \frac{E^2}{X}$$

*Measured in units of **Volt-Amps-Reactive (VAR)***

$$S = \text{apparent power} \quad S = I^2 Z \quad S = \frac{E^2}{Z} \quad S = IE$$

*Measured in units of **Volt-Amps***

$$P = (IE)(\text{power factor})$$

$$S = \sqrt{P^2 + Q^2}$$

$$\text{Power factor} = \cos (Z \text{ phase angle})$$

1.9 Decibels

$$A_{V(\text{dB})} = 20 \log A_{V(\text{ratio})} \quad A_{V(\text{ratio})} = 10^{\frac{A_{V(\text{dB})}}{20}}$$

$$A_{I(\text{dB})} = 20 \log A_{I(\text{ratio})} \quad A_{I(\text{ratio})} = 10^{\frac{A_{I(\text{dB})}}{20}}$$

$$A_{P(\text{dB})} = 10 \log A_{P(\text{ratio})} \quad A_{P(\text{ratio})} = 10^{\frac{A_{P(\text{dB})}}{10}}$$

1.10 Metric prefixes and unit conversions

- **Metric prefixes**
- Yotta = 10^{24} Symbol: Y
- Zetta = 10^{21} Symbol: Z
- Exa = 10^{18} Symbol: E
- Peta = 10^{15} Symbol: P
- Tera = 10^{12} Symbol: T
- Giga = 10^9 Symbol: G
- Mega = 10^6 Symbol: M
- Kilo = 10^3 Symbol: k
- Hecto = 10^2 Symbol: h
- Deca = 10^1 Symbol: da
- Deci = 10^{-1} Symbol: d
- Centi = 10^{-2} Symbol: c
- Milli = 10^{-3} Symbol: m
- Micro = 10^{-6} Symbol: μ
- Nano = 10^{-9} Symbol: n
- Pico = 10^{-12} Symbol: p
- Femto = 10^{-15} Symbol: f
- Atto = 10^{-18} Symbol: a
- Zepto = 10^{-21} Symbol: z
- Yocto = 10^{-24} Symbol: y

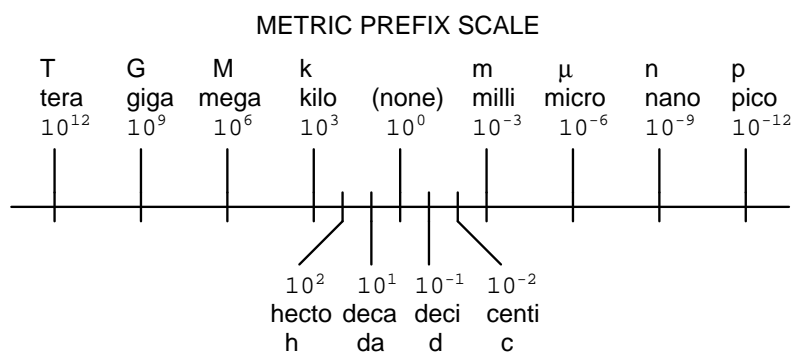

- **Conversion factors for temperature**

- $^{\circ}\text{F} = (^{\circ}\text{C})(9/5) + 32$
- $^{\circ}\text{C} = (^{\circ}\text{F} - 32)(5/9)$
- $^{\circ}\text{R} = ^{\circ}\text{F} + 459.67$
- $^{\circ}\text{K} = ^{\circ}\text{C} + 273.15$

Conversion equivalencies for volume

1 gallon (gal) = 231.0 cubic inches (in³) = 4 quarts (qt) = 8 pints (pt) = 128 fluid ounces (fl. oz.) = 3.7854 liters (l)

Conversion equivalencies for distance

1 inch (in) = 2.540000 centimeter (cm)

Conversion equivalencies for velocity

1 mile per hour (mi/h) = 88 feet per minute (ft/m) = 1.46667 feet per second (ft/s)
 = 1.60934 kilometer per hour (km/h) = 0.44704 meter per second (m/s) = 0.868976
 knot (knot – international)

Conversion equivalencies for weight

1 pound (lb) = 16 ounces (oz) = 0.45359 kilogram (kg)

Conversion equivalencies for force

1 pound-force (lbf) = 4.44822 newton (N)

Acceleration of gravity (free fall), Earth standard

9.806650 meters per second per second (m/s²) = 32.1740 feet per second per second (ft/s²)

Conversion equivalencies for area

1 acre = 43560 square feet (ft²) = 4840 square yards (yd²) = 4046.86 square meters (m²)

Conversion equivalencies for pressure

1 pound per square inch (psi) = 2.03603 inches of mercury (in. Hg) = 27.6807 inches of water (in. W.C.) = 6894.757 pascals (Pa) = 0.0680460 atmospheres (Atm) = 0.0689476 bar (bar)

Conversion equivalencies for energy or work

1 british thermal unit (BTU – "International Table") = 251.996 calories (cal – "International Table") = 1055.06 joules (J) = 1055.06 watt-seconds (W-s) = 0.293071 watt-hour (W-hr) = 1.05506×10^{10} ergs (erg) = 778.169 foot-pound-force (ft-lbf)

Conversion equivalencies for power

1 horsepower (hp – 550 ft-lbf/s) = 745.7 watts (W) = 2544.43 british thermal units per hour (BTU/hr) = 0.0760181 boiler horsepower (hp – boiler)

Converting between units is easy if you have a set of equivalencies to work with. Suppose we wanted to convert an energy quantity of 2500 calories into watt-hours. What we would need to do is find a set of equivalent figures for those units. In our reference here, we see that 251.996 calories is physically equal to 0.293071 watt hour. To convert from calories into watt-hours, we must form a "unity fraction" with these physically equal figures (a fraction composed of different figures and different units, the numerator and denominator being *physically* equal to one another), placing the desired unit in the numerator and the initial unit in the denominator, and then multiply our initial value of calories by that fraction.

Since both terms of the "unity fraction" are physically equal to one another, the fraction as a whole has a *physical* value of 1, and so does not change the true value of any figure when multiplied by it. When units are canceled, however, there will be a change in units. For example, 2500 calories multiplied by the unity fraction of $(0.293071 \text{ w-hr} / 251.996 \text{ cal}) = 2.9075 \text{ watt-hours}$.

Original figure

2500 calories

"Unity fraction"

$\frac{0.293071 \text{ watt-hour}}{251.996 \text{ calories}}$

... *cancelling units* ...

$\frac{2500 \cancel{\text{ calories}}}{1} \times \frac{0.293071 \text{ watt-hour}}{251.996 \cancel{\text{ calories}}}$

Converted figure

2.9075 watt-hours

The "unity fraction" approach to unit conversion may be extended beyond single steps. Suppose we wanted to convert a fluid flow measurement of 175 gallons per hour into liters per day. We have two units to convert here: gallons into liters, and hours into days. Remember that the word "per" in mathematics means "divided by," so our initial figure of 175 gallons *per* hour means 175 gallons divided by hours. Expressing our original figure as such a fraction, we multiply it by the necessary unity fractions to convert gallons to liters (3.7854 liters = 1 gallon), and hours to days (1 day = 24 hours). The units must be arranged in the unity fraction in such a way that undesired units cancel each other out above and below fraction bars. For this problem it means using a gallons-to-liters unity fraction of (3.7854 liters / 1 gallon) and a hours-to-days unity fraction of (24 hours / 1 day):

Original figure 175 gallons/hour

"Unity fraction"

$$\frac{3.7854 \text{ liters}}{1 \text{ gallon}}$$

"Unity fraction"

$$\frac{24 \text{ hours}}{1 \text{ day}}$$

. . . cancelling units . . .

$$\frac{175 \cancel{\text{ gallons}}}{1 \cancel{\text{ hour}}} \quad \frac{3.7854 \text{ liters}}{1 \cancel{\text{ gallon}}} \quad \frac{24 \cancel{\text{ hours}}}{1 \text{ day}}$$

Converted figure 15,898.68 liters/day

Our final (converted) answer is 15898.68 liters per day.

1.11 Data

Conversion factors were found in the 78th edition of the *CRC Handbook of Chemistry and Physics*, and the 3rd edition of Bela Liptak's *Instrument Engineers' Handbook – Process Measurement and Analysis*.

Chapter 2

RESISTOR COLOR CODES

Color	Digit	Multiplier	Tolerance (%)
Black	0	10^0 (1)	
Brown	1	10^1	1
Red	2	10^2	2
Orange	3	10^3	
Yellow	4	10^4	
Green	5	10^5	0.5
Blue	6	10^6	0.25
Violet	7	10^7	0.1
Grey	8	10^8	
White	9	10^9	
Gold		10^{-1}	5
Silver		10^{-2}	10
(none)			20

The colors brown, red, green, blue, and violet are used as tolerance codes on 5-band resistors only. All 5-band resistors use a colored tolerance band. The blank (20%) "band" is only used with the "4-band" code (3 colored bands + a blank "band").

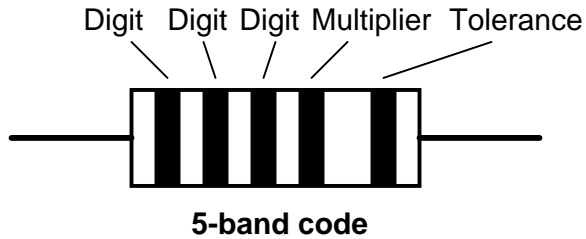
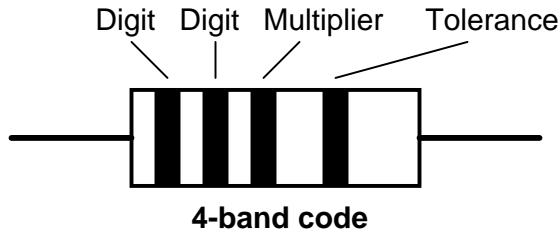

2.1 Example #1



A resistor colored *Yellow-Violet-Orange-Gold* would be 47 k Ω with a tolerance of $\pm 5\%$.

2.2 Example #2



A resistor colored *Green-Red-Gold-Silver* would be 5.2 Ω with a tolerance of $\pm 10\%$.

2.3 Example #3



A resistor colored *White-Violet-Black* would be 97 Ω with a tolerance of $\pm 20\%$. When you see only three color bands on a resistor, you know that it is actually a 4-band code with a blank (20%) tolerance band.

2.4 Example #4



A resistor colored *Orange-Orange-Black-Brown-Violet* would be $3.3 \text{ k}\Omega$ with a tolerance of $\pm 0.1\%$.

2.5 Example #5



A resistor colored *Brown-Green-Grey-Silver-Red* would be 1.58Ω with a tolerance of $\pm 2\%$.

2.6 Example #6



A resistor colored *Blue-Brown-Green-Silver-Blue* would be 6.15Ω with a tolerance of $\pm 0.25\%$.

Chapter 3

CONDUCTOR AND INSULATOR TABLES

3.1 Copper wire gage table

Soild copper wire table:

Size AWG	Diameter inches	Cross-sectional area		Weight lb/1000 ft
		cir. mils	sq. inches	
4/0	0.4600	211,600	0.1662	640.5
3/0	0.4096	167,800	0.1318	507.9
2/0	0.3648	133,100	0.1045	402.8
1/0	0.3249	105,500	0.08289	319.5
1	0.2893	83,690	0.06573	253.5
2	0.2576	66,370	0.05213	200.9
3	0.2294	52,630	0.04134	159.3
4	0.2043	41,740	0.03278	126.4
5	0.1819	33,100	0.02600	100.2
6	0.1620	26,250	0.02062	79.46
7	0.1443	20,820	0.01635	63.02
8	0.1285	16,510	0.01297	49.97
9	0.1144	13,090	0.01028	39.63
10	0.1019	10,380	0.008155	31.43
11	0.09074	8,234	0.006467	24.92
12	0.08081	6,530	0.005129	19.77
13	0.07196	5,178	0.004067	15.68
14	0.06408	4,107	0.003225	12.43
15	0.05707	3,257	0.002558	9.858
16	0.05082	2,583	0.002028	7.818
17	0.04526	2,048	0.001609	6.200
18	0.04030	1,624	0.001276	4.917

6	-----	80	-----	95	-----	105
4	-----	105	-----	125	-----	140
2	-----	140	-----	170	-----	190
1	-----	165	-----	195	-----	220
1/0	-----	195	-----	230	-----	260
2/0	-----	225	-----	265	-----	300
3/0	-----	260	-----	310	-----	350
4/0	-----	300	-----	360	-----	405

* = estimated values; normally, wire gages this small are not manufactured with these insulation types.

3.3 Coefficients of specific resistance

Specific resistance at 20° C:

Material	Element/Alloy	(ohm-cmil/ft)	(ohm-cm)
Nichrome	----- Alloy	675	112.2 ⁻⁶
Nichrome V	----- Alloy	650	108.1 ⁻⁶
Manganin	----- Alloy	290	48.21 ⁻⁶
Constantan	----- Alloy	272.97	45.38 ⁻⁶
Steel*	----- Alloy	100	16.62 ⁻⁶
Platinum	----- Element	63.16	10.5 ⁻⁶
Iron	----- Element	57.81	9.61 ⁻⁶
Nickel	----- Element	41.69	6.93 ⁻⁶
Zinc	----- Element	35.49	5.90 ⁻⁶
Molybdenum	----- Element	32.12	5.34 ⁻⁶
Tungsten	----- Element	31.76	5.28 ⁻⁶
Aluminum	----- Element	15.94	2.650 ⁻⁶
Gold	----- Element	13.32	2.214 ⁻⁶
Copper	----- Element	10.09	1.678 ⁻⁶
Silver	----- Element	9.546	1.587 ⁻⁶

* = Steel alloy at 99.5 percent iron, 0.5 percent carbon.

3.4 Temperature coefficients of resistance

Temperature coefficient (α) per degree C:

Material	Element/Alloy	Temp. coefficient
Nickel	----- Element	0.005866
Iron	----- Element	0.005671
Molybdenum	----- Element	0.004579
Tungsten	----- Element	0.004403
Aluminum	----- Element	0.004308

Copper	-----	Element	-----	0.004041
Silver	-----	Element	-----	0.003819
Platinum	-----	Element	-----	0.003729
Gold	-----	Element	-----	0.003715
Zinc	-----	Element	-----	0.003847
Steel*	-----	Alloy	-----	0.003
Nichrome	-----	Alloy	-----	0.00017
Nichrome V	-----	Alloy	-----	0.00013
Manganin	-----	Alloy	-----	+/- 0.000015
Constantan	-----	Alloy	-----	-0.000074

* = Steel alloy at 99.5 percent iron, 0.5 percent carbon

3.5 Critical temperatures for superconductors

Critical temperatures given in degrees Kelvin:

Material	Element/Alloy	Critical temperature
Aluminum	----- Element	----- 1.20
Cadmium	----- Element	----- 0.56
Lead	----- Element	----- 7.2
Mercury	----- Element	----- 4.16
Niobium	----- Element	----- 8.70
Thorium	----- Element	----- 1.37
Tin	----- Element	----- 3.72
Titanium	----- Element	----- 0.39
Uranium	----- Element	----- 1.0
Zinc	----- Element	----- 0.91
Niobium/Tin	----- Alloy	----- 18.1
Cupric sulphide	- Compound	----- 1.6

Note: all critical temperatures given at zero magnetic field strength.

3.6 Dielectric strengths for insulators

Dielectric strength in kilovolts per inch (kV/in):

Material*	Dielectric strength
Vacuum	----- 20
Air	----- 20 to 75
Porcelain	----- 40 to 200
Paraffin Wax	----- 200 to 300
Transformer Oil	----- 400
Bakelite	----- 300 to 550
Rubber	----- 450 to 700

Shellac -----	900
Paper -----	1250
Teflon -----	1500
Glass -----	2000 to 3000
Mica -----	5000

* = Materials listed are specially prepared for electrical use

3.7 Data

Tables of specific resistance and temperature coefficient of resistance for elemental materials (not alloys) were derived from figures found in the 78th edition of the CRC Handbook of Chemistry and Physics. Superconductivity data from Collier's Encyclopedia (volume 21, 1968, page 640).

Chapter 4

ALGEBRA REFERENCE

4.1 Basic identities

$$a + 0 = a \qquad 1a = a \qquad 0a = 0$$

$$\frac{a}{1} = a \qquad \frac{0}{a} = 0 \qquad \frac{a}{a} = 1$$

$$\frac{a}{0} = \textit{undefined}$$

Note: while division by zero is popularly thought to be equal to infinity, this is not technically true. In some practical applications it may be helpful to think the result of such a fraction *approaching* infinity as the denominator *approaches* zero (imagine calculating current $I=E/R$ in a circuit with resistance approaching zero – current would approach infinity), but the actual fraction of anything divided by zero is undefined in the scope of "real" numbers.

4.2 Arithmetic properties

4.2.1 The associative property

In addition and multiplication, terms may be arbitrarily *associated* with each other through the use of parentheses:

$$a + (b + c) = (a + b) + c \qquad a(bc) = (ab)c$$

4.2.2 The commutative property

In addition and multiplication, terms may be arbitrarily interchanged, or *commutated*:

$$a + b = b + a \qquad ab=ba$$

4.2.3 The distributive property

$$a(b + c) = ab + ac$$

4.3 Properties of exponents

$$a^m a^n = a^{m+n} \quad (ab)^m = a^m b^m$$

$$(a^m)^n = a^{mn} \quad \frac{a^m}{a^n} = a^{m-n}$$

4.4 Radicals

4.4.1 Definition of a radical

When people talk of a "square root," they're referring to a radical with a root of 2. This is mathematically equivalent to a number raised to the power of $1/2$. This equivalence is useful to know when using a calculator to determine a strange root. Suppose for example you needed to find the fourth root of a number, but your calculator lacks a "4th root" button or function. If it has a y^x function (which any scientific calculator should have), you can find the fourth root by raising that number to the $1/4$ power, or $x^{0.25}$.

$$\sqrt[x]{a} = a^{1/x}$$

It is important to remember that when solving for an *even* root (square root, fourth root, etc.) of any number, there are *two* valid answers. For example, most people know that the square root of nine is three, but *negative* three is also a valid answer, since $(-3)^2 = 9$ just as $3^2 = 9$.

4.4.2 Properties of radicals

$$\sqrt[x]{a^x} = a \quad \sqrt[x]{a^x} = a$$

$$\sqrt[x]{ab} = \sqrt[x]{a} \sqrt[x]{b}$$

$$\sqrt[x]{\frac{a}{b}} = \frac{\sqrt[x]{a}}{\sqrt[x]{b}}$$

4.5 Important constants

4.5.1 Euler's number

Euler's constant is an important value for exponential functions, especially scientific applications involving decay (such as the decay of a radioactive substance). It is especially important in calculus due to its uniquely self-similar properties of integration and differentiation.

e approximately equals:

2.71828 18284 59045 23536 02874 71352 66249 77572 47093 69996

$$e = \sum_{k=0}^{\infty} \frac{1}{k!}$$

$$\frac{1}{0!} + \frac{1}{1!} + \frac{1}{2!} + \frac{1}{3!} + \cdots + \frac{1}{n!}$$

4.5.2 Pi

Pi (π) is defined as the ratio of a circle's circumference to its diameter.

Pi approximately equals:

3.14159 26535 89793 23846 26433 83279 50288 41971 69399 37511

Note: For both Euler's constant (e) and pi (π), the spaces shown between each set of five digits have no mathematical significance. They are placed there just to make it easier for your eyes to "piece" the number into five-digit groups when manually copying.

4.6 Logarithms

4.6.1 Definition of a logarithm

If:

$$b^y = x$$

Then:

$$\log_b x = y$$

Where,

b = "Base" of the logarithm

"log" denotes a common logarithm (base = 10), while "ln" denotes a natural logarithm (base = e).

4.6.2 Properties of logarithms

$$(\log a) + (\log b) = \log ab$$

$$(\log a) - (\log b) = \log \frac{a}{b}$$

$$\log a^m = (m)(\log a)$$

These properties of logarithms come in handy for performing complex multiplication and division operations. They are an example of something called a *transform function*, whereby one type of mathematical operation is transformed into another type of mathematical operation that is simpler to solve. Using a table of logarithm figures, one can multiply or divide numbers by adding or subtracting their logarithms, respectively. then looking up that logarithm figure in the table and seeing what the final product or quotient is.

Slide rules work on this principle of logarithms by performing multiplication and division through addition and subtraction of distances on the slide.

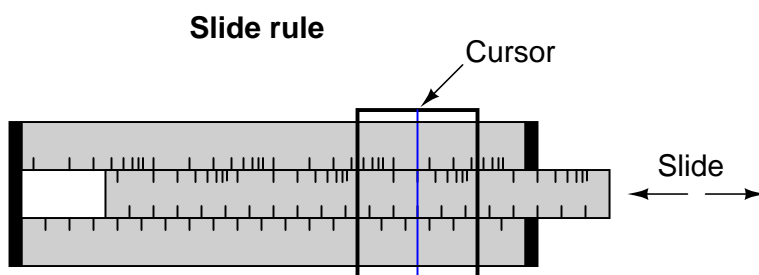

Numerical quantities are represented by the positioning of the slide.

Marks on a slide rule's scales are spaced in a logarithmic fashion, so that a linear positioning of the scale or cursor results in a nonlinear indication as read on the scale(s). Adding or subtracting lengths on these logarithmic scales results in an indication equivalent to the product or quotient, respectively, of those lengths.

Most slide rules were also equipped with special scales for trigonometric functions, powers, roots, and other useful arithmetic functions.

4.7 Factoring equivalencies

$$x^2 - y^2 = (x+y)(x-y)$$

$$x^3 - y^3 = (x-y)(x^2 + xy + y^2)$$

4.8 The quadratic formula

For a polynomial expression in the form of: $ax^2 + by + c = 0$

$$x = \frac{-b \pm \sqrt{b^2 - 4ac}}{2a}$$

4.9 Sequences

4.9.1 Arithmetic sequences

An *arithmetic sequence* is a series of numbers obtained by adding (or subtracting) the same value with each step. A child's counting sequence (1, 2, 3, 4, . . .) is a simple arithmetic sequence, where the *common difference* is 1: that is, each adjacent number in the sequence differs by a value of one. An arithmetic sequence counting only even numbers (2, 4, 6, 8, . . .) or only odd numbers (1, 3, 5, 7, 9, . . .) would have a common difference of 2.

In the standard notation of sequences, a lower-case letter "a" represents an element (a single number) in the sequence. The term " a_n " refers to the element at the n^{th} step in the sequence. For example, " a_3 " in an even-counting (common difference = 2) arithmetic sequence starting at 2 would be the number 6, "a" representing 4 and " a_1 " representing the starting point of the sequence (given in this example as 2).

A capital letter "A" represents the *sum* of an arithmetic sequence. For instance, in the same even-counting sequence starting at 2, A_4 is equal to the sum of all elements from a_1 through a_4 , which of course would be $2 + 4 + 6 + 8$, or 20.

$$a_n = a_{n-1} + d \quad a_n = a_1 + d(n-1)$$

Where:

d = The "common difference"

Example of an arithmetic sequence:

-7, -3, 1, 5, 9, 13, 17, 21, 25 . . .

$$A_n = a_1 + a_2 + \dots + a_n$$

$$A_n = \frac{n}{2} (a_1 + a_n)$$

4.9.2 Geometric sequences

A *geometric sequence*, on the other hand, is a series of numbers obtained by multiplying (or dividing) by the same value with each step. A binary place-weight sequence (1, 2, 4, 8, 16, 32, 64, . . .) is a simple geometric sequence, where the *common ratio* is 2: that is, each adjacent number in the sequence differs by a *factor* of two.

$$a_n = r(a_{n-1}) \quad a_n = a_1(r^{n-1})$$

Where:

r = The "common ratio"

Example of a geometric sequence:

3, 12, 48, 192, 768, 3072 . . .

$$A_n = a_1 + a_2 + \dots + a_n$$

$$A_n = \frac{a_1(1 - r^n)}{1 - r}$$

4.10 Factorials

4.10.1 Definition of a factorial

Denoted by the symbol "!" after an integer; the product of that integer and all integers in descent to 1.

Example of a factorial:

$$5! = 5 \times 4 \times 3 \times 2 \times 1$$

$$5! = 120$$

4.10.2 Strange factorials

$$0! = 1 \quad 1! = 1$$

4.11 Solving simultaneous equations

The terms *simultaneous equations* and *systems of equations* refer to conditions where two or more unknown variables are related to each other through an equal number of equations. Consider the following example:

$$x + y = 24$$

$$2x - y = -6$$

For this set of equations, there is but a single combination of values for x and y that will satisfy both. Either equation, considered separately, has an infinitude of valid (x, y) solutions, but *together* there is only one. Plotted on a graph, this condition becomes obvious:

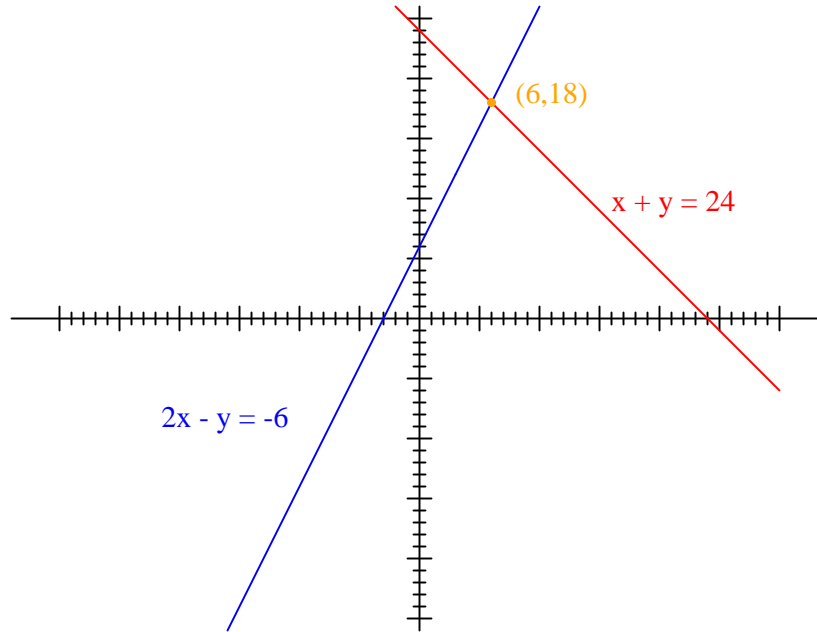

Each line is actually a continuum of points representing possible x and y solution pairs for each equation. Each equation, separately, has an infinite number of ordered pair (x, y) solutions. There is only one point where the two linear functions $x + y = 24$ and $2x - y = -6$ intersect (where one of their many independent solutions happen to work for both equations), and that is where x is equal to a value of 6 and y is equal to a value of 18.

Usually, though, graphing is not a very efficient way to determine the simultaneous solution set for two or more equations. It is especially impractical for systems of three or more variables. In a three-variable system, for example, the solution would be found by the point intersection of three planes in a three-dimensional coordinate space – not an easy scenario to visualize.

4.11.1 Substitution method

Several algebraic techniques exist to solve simultaneous equations. Perhaps the easiest to comprehend is the *substitution* method. Take, for instance, our two-variable example problem:

$$x + y = 24$$

$$2x - y = -6$$

In the substitution method, we manipulate one of the equations such that one variable is defined in terms of the other:

$$x + y = 24$$



$$y = 24 - x$$

Defining y in terms of x

Then, we take this new *definition* of one variable and *substitute* it for the same variable in the other equation. In this case, we take the definition of y , which is $24 - x$ and substitute this for the y term found in the other equation:

$$y = 24 - x$$

↓ *substitute*

$$2x - y = -6$$



$$2x - (24 - x) = -6$$

Now that we have an equation with just a single variable (x), we can solve it using "normal" algebraic techniques:

$$2x - (24 - x) = -6$$



Distributive property

$$2x - 24 + x = -6$$



Combining like terms

$$3x - 24 = -6$$



Adding 24 to each side

$$3x = 18$$



Dividing both sides by 3

$$x = 6$$

Now that x is known, we can plug this value into any of the original equations and obtain a value for y . Or, to save us some work, we can plug this value (6) into the equation we just generated to define y in terms of x , being that it is already in a form to solve for y :

$$\begin{array}{l}
 x = 6 \\
 \downarrow \textit{substitute} \\
 y = 24 - x \\
 \Downarrow \\
 y = 24 - 6 \\
 \Downarrow \\
 y = 18
 \end{array}$$

Applying the substitution method to systems of three or more variables involves a similar pattern, only with more work involved. This is generally true for any method of solution: the number of steps required for obtaining solutions increases rapidly with each additional variable in the system.

To solve for three unknown variables, we need at least three equations. Consider this example:

$$\begin{array}{l}
 x - y + z = 10 \\
 3x + y + 2z = 34 \\
 -5x + 2y - z = -14
 \end{array}$$

Being that the first equation has the simplest coefficients (1, -1, and 1, for x , y , and z , respectively), it seems logical to use it to develop a definition of one variable in terms of the other two. In this example, I'll solve for x in terms of y and z :

$$\begin{array}{l}
 x - y + z = 10 \\
 \Downarrow \text{Adding } y \text{ and subtracting } z \\
 \quad \quad \quad \text{from both sides} \\
 x = y - z + 10
 \end{array}$$

Now, we can substitute this definition of x where x appears in the other two equations:

$$\begin{array}{ll}
 \begin{array}{l}
 x = y - z + 10 \\
 \downarrow \textit{substitute} \\
 3x + y + 2z = 34 \\
 \Downarrow \\
 3(y - z + 10) + y + 2z = 34
 \end{array} &
 \begin{array}{l}
 x = y - z + 10 \\
 \downarrow \textit{substitute} \\
 -5x + 2y - z = -14 \\
 \Downarrow \\
 -5(y - z + 10) + 2y - z = -14
 \end{array}
 \end{array}$$

Reducing these two equations to their simplest forms:

$$\begin{array}{rcl}
 3(y - z + 10) + y + 2z = 34 & & -5(y - z + 10) + 2y - z = -14 \\
 \Downarrow & \text{Distributive property} & \Downarrow \\
 3y - 3z + 30 + y + 2z = 34 & & -5y + 5z - 50 + 2y - z = -14 \\
 \Downarrow & \text{Combining like terms} & \Downarrow \\
 4y - z + 30 = 34 & & -3y + 4z - 50 = -14 \\
 \Downarrow & \text{Moving constant values to right} & \Downarrow \\
 & \text{of the "=" sign} & \\
 4y - z = 4 & & -3y + 4z = 36
 \end{array}$$

So far, our efforts have reduced the system from three variables in three equations to two variables in two equations. Now, we can apply the substitution technique again to the two equations $4y - z = 4$ and $-3y + 4z = 36$ to solve for either y or z . First, I'll manipulate the first equation to define z in terms of y :

$$\begin{array}{r}
 4y - z = 4 \\
 \Downarrow \text{ Adding } z \text{ to both sides;} \\
 \text{subtracting } 4 \text{ from both sides} \\
 z = 4y - 4
 \end{array}$$

Next, we'll substitute this definition of z in terms of y where we see z in the other equation:

$$\begin{array}{r}
 z = 4y - 4 \\
 \downarrow \text{ substitute} \\
 -3y + 4z = 36 \\
 \Downarrow \\
 -3y + 4(4y - 4) = 36 \\
 \Downarrow \text{ Distributive property} \\
 -3y + 16y - 16 = 36 \\
 \Downarrow \text{ Combining like terms} \\
 13y - 16 = 36 \\
 \Downarrow \text{ Adding } 16 \text{ to both sides} \\
 13y = 52 \\
 \Downarrow \text{ Dividing both sides by } 13 \\
 y = 4
 \end{array}$$

Now that y is a known value, we can plug it into the equation defining z in terms of y and obtain a figure for z :

$$\begin{array}{l}
 y = 4 \\
 \downarrow \textit{substitute} \\
 z = 4y - 4 \\
 \Downarrow \\
 z = 16 - 4 \\
 \Downarrow \\
 z = 12
 \end{array}$$

Now, with values for y and z known, we can plug these into the equation where we defined x in terms of y and z , to obtain a value for x :

$$\begin{array}{l}
 y = 4 \\
 \downarrow \textit{substitute} \\
 x = y - z + 10 \\
 \Downarrow \\
 x = 4 - 12 + 10 \\
 \Downarrow \\
 x = 2
 \end{array}
 \quad
 \begin{array}{l}
 z = 12 \\
 \downarrow \textit{substitute}
 \end{array}$$

In closing, we've found values for x , y , and z of 2, 4, and 12, respectively, that satisfy all three equations.

4.11.2 Addition method

While the substitution method may be the easiest to grasp on a conceptual level, there are other methods of solution available to us. One such method is the so-called *addition* method, whereby equations are added to one another for the purpose of canceling variable terms.

Let's take our two-variable system used to demonstrate the substitution method:

$$x + y = 24$$

$$2x - y = -6$$

One of the most-used rules of algebra is that you may perform any arithmetic operation you wish to an equation so long as you do it *equally to both sides*. With reference to addition, this means we may add any quantity we wish to both sides of an equation – so long as it's the *same* quantity – without altering the truth of the equation.

An option we have, then, is to add the corresponding sides of the equations together to form a new equation. Since each equation is an expression of equality (the same quantity on either side of the = sign), adding the left-hand side of one equation to the left-hand side of the other equation is valid so long as we add the two equations' right-hand sides together as well. In our example equation set, for instance, we may add $x + y$ to $2x - y$, and add 24 and -6 together as well to form a new equation. What benefit does this hold for us? Examine what happens when we do this to our example equation set:

$$\begin{array}{r} x + y = 24 \\ + 2x - y = -6 \\ \hline 3x + 0 = 18 \end{array}$$

Because the top equation happened to contain a positive y term while the bottom equation happened to contain a negative y term, these two terms canceled each other in the process of addition, leaving no y term in the sum. What we have left is a new equation, but one with only a single unknown variable, x ! This allows us to easily solve for the value of x :

$$\begin{array}{l} 3x + 0 = 18 \\ \Downarrow \text{ Dropping the 0 term} \\ 3x = 18 \\ \Downarrow \text{ Dividing both sides by 3} \\ x = 6 \end{array}$$

Once we have a known value for x , of course, determining y 's value is a simply matter of substitution (replacing x with the number 6) into one of the original equations. In this example, the technique of adding the equations together worked well to produce an equation with a single unknown variable. What about an example where things aren't so simple? Consider the following equation set:

$$\begin{array}{l} 2x + 2y = 14 \\ 3x + y = 13 \end{array}$$

We could add these two equations together – this being a completely valid algebraic operation – but it would not profit us in the goal of obtaining values for x and y :

$$\begin{array}{r} 2x + 2y = 14 \\ + 3x + y = 13 \\ \hline 5x + 3y = 27 \end{array}$$

The resulting equation still contains two unknown variables, just like the original equations do, and so we're no further along in obtaining a solution. However, what if we could manipulate one of the equations so as to have a negative term that *would* cancel the respective term in the other equation when added? Then, the system would reduce to a single equation with a single unknown variable just as with the last (fortuitous) example.

If we could only turn the y term in the lower equation into a $-2y$ term, so that when the two equations were added together, both y terms in the equations would cancel, leaving us with only an x term, this would bring us closer to a solution. Fortunately, this is not difficult to do. If we *multiply* each and every term of the lower equation by a -2 , it will produce the result we seek:

$$-2(3x + y) = -2(13)$$

↓ Distributive property

$$-6x - 2y = -26$$

Now, we may add this new equation to the original, upper equation:

$$\begin{array}{r} 2x + 2y = 14 \\ + -6x - 2y = -26 \\ \hline -4x + 0y = -12 \end{array}$$

Solving for x , we obtain a value of 3:

$$-4x + 0y = -12$$

↓ Dropping the 0 term

$$-4x = -12$$

↓ Dividing both sides by -4

$$x = 3$$

Substituting this new-found value for x into one of the original equations, the value of y is easily determined:

$$x = 3$$

↓ *substitute*

$$2x + 2y = 14$$

↓

$$6 + 2y = 14$$

↓

Subtracting 6 from both sides

$$2y = 8$$

↓

Dividing both sides by 2

$$y = 4$$

Using this solution technique on a three-variable system is a bit more complex. As with substitution, you must use this technique to reduce the three-equation system of three variables down to

two equations with two variables, then apply it again to obtain a single equation with one unknown variable. To demonstrate, I'll use the three-variable equation system from the substitution section:

$$\begin{aligned}x - y + z &= 10 \\3x + y + 2z &= 34 \\-5x + 2y - z &= -14\end{aligned}$$

Being that the top equation has coefficient values of 1 for each variable, it will be an easy equation to manipulate and use as a cancellation tool. For instance, if we wish to cancel the $3x$ term from the middle equation, all we need to do is take the top equation, multiply each of its terms by -3 , then add it to the middle equation like this:

$$\begin{aligned}x - y + z &= 10 \\ \Downarrow & \text{Multiply both sides by } -3 \\ -3(x - y + z) &= -3(10) \\ \Downarrow & \text{Distributive property} \\ -3x + 3y - 3z &= -30\end{aligned}$$

$$\begin{array}{r} \text{(Adding)} \quad -3x + 3y - 3z = -30 \\ \quad \quad \quad + 3x + y + 2z = 34 \\ \hline \quad \quad \quad 0x + 4y - z = 4 \\ \quad \quad \quad \text{or} \\ \quad \quad \quad 4y - z = 4 \end{array}$$

We can rid the bottom equation of its $-5x$ term in the same manner: take the original top equation, multiply each of its terms by 5, then add that modified equation to the bottom equation, leaving a new equation with only y and z terms:

$$x - y + z = 10$$

↓ Multiply both sides by 5

$$5(x - y + z) = 5(10)$$

↓ Distributive property

$$5x - 5y + 5z = 50$$

$$\begin{array}{r} \text{(Adding)} \quad 5x - 5y + 5z = 50 \\ + -5x + 2y - z = -14 \\ \hline 0x - 3y + 4z = 36 \\ \text{or} \\ -3y + 4z = 36 \end{array}$$

At this point, we have two equations with the same two unknown variables, y and z :

$$4y - z = 4$$

$$-3y + 4z = 36$$

By inspection, it should be evident that the $-z$ term of the upper equation could be leveraged to cancel the $4z$ term in the lower equation if only we multiply each term of the upper equation by 4 and add the two equations together:

$$4y - z = 4$$

↓ Multiply both sides by 4

$$4(4y - z) = 4(4)$$

↓ Distributive property

$$16y - 4z = 16$$

$$\begin{array}{r} \text{(Adding)} \quad 16y - 4z = 16 \\ + -3y + 4z = 36 \\ \hline 13y + 0z = 52 \\ \text{or} \\ 13y = 52 \end{array}$$

Taking the new equation $13y = 52$ and solving for y (by dividing both sides by 13), we get a value of 4 for y . Substituting this value of 4 for y in either of the two-variable equations allows us to

solve for z . Substituting both values of y and z into any one of the original, three-variable equations allows us to solve for x . The final result (I'll spare you the algebraic steps, since you should be familiar with them by now!) is that $x = 2$, $y = 4$, and $z = 12$.

Chapter 5

TRIGONOMETRY REFERENCE

5.1 Right triangle trigonometry

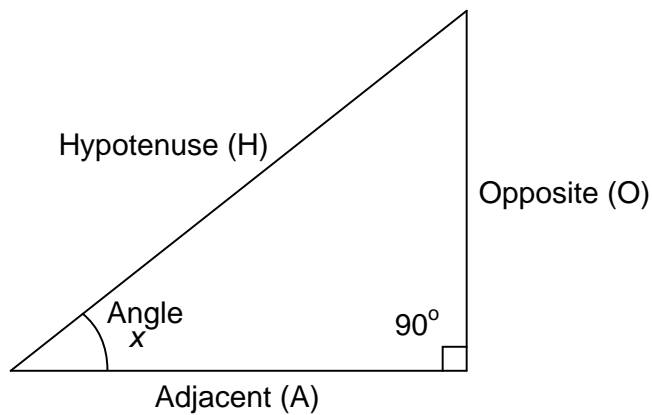

A *right triangle* is defined as having one angle precisely equal to 90° (a *right angle*).

5.1.1 Trigonometric identities

$$\sin x = \frac{O}{H} \quad \cos x = \frac{A}{H} \quad \tan x = \frac{O}{A} \quad \tan x = \frac{\sin x}{\cos x}$$

$$\csc x = \frac{H}{O} \quad \sec x = \frac{H}{A} \quad \cot x = \frac{A}{O} \quad \tan x = \frac{\cos x}{\sin x}$$

H is the *Hypotenuse*, always being opposite the right angle. Relative to angle x , O is the *Opposite* and A is the *Adjacent*.

5.1.2 The Pythagorean theorem

$$H^2 = A^2 + O^2$$

5.2 Non-right triangle trigonometry

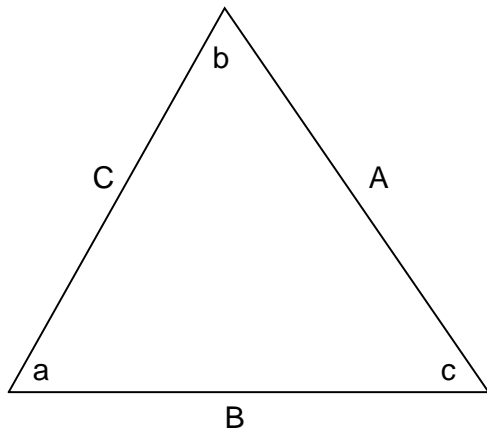

5.2.1 The Law of Sines (for *any* triangle)

$$\frac{\sin a}{A} = \frac{\sin b}{B} = \frac{\sin c}{C}$$

5.2.2 The Law of Cosines (for *any* triangle)

$$A^2 = B^2 + C^2 - (2BC)(\cos a)$$

$$B^2 = A^2 + C^2 - (2AC)(\cos b)$$

$$C^2 = A^2 + B^2 - (2AB)(\cos c)$$

5.3 Trigonometric equivalencies

$$\sin -x = -\sin x \qquad \cos -x = \cos x \qquad \tan -t = -\tan t$$

$$\csc -t = -\csc t \qquad \sec -t = \sec t \qquad \cot -t = -\cot t$$

$$\sin 2x = 2(\sin x)(\cos x) \qquad \cos 2x = (\cos^2 x) - (\sin^2 x)$$

$$\tan 2t = \frac{2(\tan x)}{1 - \tan^2 x}$$

$$\sin^2 x = \frac{1}{2} - \frac{\cos 2x}{2} \qquad \cos^2 x = \frac{1}{2} + \frac{\cos 2x}{2}$$

5.4 Hyperbolic functions

$$\sinh x = \frac{e^x - e^{-x}}{2}$$

$$\cosh x = \frac{e^x + e^{-x}}{2}$$

$$\tanh x = \frac{\sinh x}{\cosh x}$$

Note: all angles (x) must be expressed in units of *radians* for these hyperbolic functions. There are 2π radians in a circle (360°).

Chapter 6

CALCULUS REFERENCE

6.1 Rules for limits

$$\lim_{x \rightarrow a} [f(x) + g(x)] = \lim_{x \rightarrow a} f(x) + \lim_{x \rightarrow a} g(x)$$

$$\lim_{x \rightarrow a} [f(x) - g(x)] = \lim_{x \rightarrow a} f(x) - \lim_{x \rightarrow a} g(x)$$

$$\lim_{x \rightarrow a} [f(x) g(x)] = [\lim_{x \rightarrow a} f(x)] [\lim_{x \rightarrow a} g(x)]$$

6.2 Derivative of a constant

If:

$$f(x) = c$$

Then:

$$\frac{d}{dx} f(x) = 0$$

("c" being a constant)

6.3 Common derivatives

$$\frac{d}{dx} x^n = nx^{n-1}$$

$$\frac{d}{dx} \ln x = \frac{1}{x}$$

$$\frac{d}{dx} a^x = (a^n)(\ln a)$$

6.4 Derivatives of power functions of e

If:
 $f(x) = e^x$

If:
 $f(x) = e^{g(x)}$

Then:
 $\frac{d}{dx} f(x) = e^x$

Then:
 $\frac{d}{dx} f(x) = e^{g(x)} \frac{d}{dx} g(x)$

Example:

$$f(x) = e^{(x^2 + 2x)}$$

$$\frac{d}{dx} f(x) = e^{(x^2 + 2x)} \frac{d}{dx} (x^2 + 2x)$$

$$\frac{d}{dx} f(x) = (e^{(x^2 + 2x)})(2x + 2)$$

6.5 Trigonometric derivatives

$$\frac{d}{dx} \sin x = \cos x$$

$$\frac{d}{dx} \cos x = -\sin x$$

$$\frac{d}{dx} \tan x = \sec^2 x$$

$$\frac{d}{dx} \cot x = -\csc^2 x$$

$$\frac{d}{dx} \sec x = (\sec x)(\tan x)$$

$$\frac{d}{dx} \csc x = (-\csc x)(\cot x)$$

6.6 Rules for derivatives

6.6.1 Constant rule

$$\frac{d}{dx} [cf(x)] = c \frac{d}{dx} f(x)$$

6.6.2 Rule of sums

$$\frac{d}{dx} [f(x) + g(x)] = \frac{d}{dx} f(x) + \frac{d}{dx} g(x)$$

6.6.3 Rule of differences

$$\frac{d}{dx} [f(x) - g(x)] = \frac{d}{dx} f(x) - \frac{d}{dx} g(x)$$

6.6.4 Product rule

$$\frac{d}{dx} [f(x) g(x)] = f(x) \left[\frac{d}{dx} g(x) \right] + g(x) \left[\frac{d}{dx} f(x) \right]$$

6.6.5 Quotient rule

$$\frac{d}{dx} \frac{f(x)}{g(x)} = \frac{g(x) \left[\frac{d}{dx} f(x) \right] - f(x) \left[\frac{d}{dx} g(x) \right]}{[g(x)]^2}$$

6.6.6 Power rule

$$\frac{d}{dx} f(x)^a = a[f(x)]^{a-1} \frac{d}{dx} f(x)$$

6.6.7 Functions of other functions

$$\frac{d}{dx} f[g(x)]$$

Break the function into two functions:

$$u = g(x) \quad \text{and} \quad y = f(u)$$

Solve:

$$\frac{dy}{dx} f[g(x)] = \frac{dy}{du} f(u) \frac{du}{dx} g(x)$$

6.7 The antiderivative (Indefinite integral)

If:

$$\frac{d}{dx} f(x) = g(x)$$

Then:

$g(x)$ is the *derivative* of $f(x)$

$f(x)$ is the *antiderivative* of $g(x)$

$$\int g(x) dx = f(x) + c$$

Notice something important here: taking the derivative of $f(x)$ may precisely give you $g(x)$, but taking the antiderivative of $g(x)$ does not necessarily give you $f(x)$ in its original form. Example:

$$f(x) = 3x^2 + 5$$

$$\frac{d}{dx} f(x) = 6x$$

$$\int 6x dx = 3x^2 + c$$

Note that the constant c is unknown! The original function $f(x)$ could have been $3x^2 + 5$, $3x^2 + 10$, $3x^2 + \textit{anything}$, and the derivative of $f(x)$ would have still been $6x$. Determining the antiderivative of a function, then, is a bit less certain than determining the derivative of a function.

6.8 Common antiderivatives

$$\int x^n dx = \frac{x^{n+1}}{n+1} + c$$

$$\int \frac{1}{x} dx = (\ln |x|) + c$$

Where,

$c = \text{a constant}$

$$\int a^x dx = \frac{a^x}{\ln a} + c$$

6.9 Antiderivatives of power functions of e

$$\int e^x dx = e^x + c$$

Note: this is a very unique and useful property of e . As in the case of derivatives, the antiderivative of such a function is that same function. In the case of the antiderivative, a constant term "c" is added to the end as well.

6.10 Rules for antiderivatives

6.10.1 Constant rule

$$\int cf(x) dx = c \int f(x) dx$$

6.10.2 Rule of sums

$$\int [f(x) + g(x)] dx = [\int f(x) dx] + [\int g(x) dx]$$

6.10.3 Rule of differences

$$\int [f(x) - g(x)] dx = [\int f(x) dx] - [\int g(x) dx]$$

6.11 Definite integrals and the fundamental theorem of calculus

If:

$$\int f(x) \, dx = g(x) \quad \text{or} \quad \frac{d}{dx} g(x) = f(x)$$

Then:

$$\int_a^b f(x) \, dx = g(b) - g(a)$$

Where,

a and b are constants

If:

$$\int f(x) \, dx = g(x) \quad \text{and} \quad a = 0$$

Then:

$$\int_0^x f(x) \, dx = g(x)$$

6.12 Differential equations

As opposed to normal equations where the solution is a number, a differential equation is one where the solution is actually a function, and which at least one derivative of that unknown function is part of the equation.

As with finding antiderivatives of a function, we are often left with a solution that encompasses more than one possibility (consider the many possible values of the constant "c" typically found in antiderivatives). The set of functions which answer any differential equation is called the "general solution" for that differential equation. Any one function out of that set is referred to as a "particular solution" for that differential equation. The variable of reference for differentiation and integration within the differential equation is known as the "independent variable."

Chapter 7

USING THE *SPICE* CIRCUIT SIMULATION PROGRAM

7.1 Introduction

”With Electronics Workbench, you can create circuit schematics that look just the same as those you’re already familiar with on paper – plus you can flip the power switch so the schematic behaves like a real circuit. With other electronics simulators, you may have to type in SPICE node lists as text files – an abstract representation of a circuit beyond the capabilities of all but advanced electronics engineers.”

(Electronics Workbench User’s guide – version 4, page 7)

This introduction comes from the operating manual for a circuit simulation program called *Electronics Workbench*. Using a graphic interface, it allows the user to draw a circuit schematic and then have the computer analyze that circuit, displaying the results in graphic form. It is a very valuable analysis tool, but it has its shortcomings. For one, it and other graphic programs like it tend to be unreliable when analyzing complex circuits, as the translation from picture to computer code is not quite the exact science we would want it to be (yet). Secondly, due to its graphics requirements, it tends to need a significant amount of computational ”horsepower” to run, and a computer operating system that supports graphics. Thirdly, these graphic programs can be costly.

However, underneath the graphics skin of *Electronics Workbench* lies a robust (and free!) program called SPICE, which analyzes a circuit based on a text-file description of the circuit’s components and connections. What the user pays for with *Electronics Workbench* and other graphic circuit analysis programs is the convenient ”point and click” interface, while SPICE does the actual mathematical analysis.

By itself, SPICE does not require a graphic interface and demands little in system resources. It is also very reliable. The makers of Electronic Workbench would like you to think that using SPICE in its native text mode is a task suited for rocket scientists, but I’m writing this to prove them wrong. SPICE is fairly easy to use for simple circuits, and its non-graphic interface actually lends itself toward the analysis of circuits that can be difficult to draw. I think it was the programming expert Donald Knuth who quipped, ”What you see is all you get” when it comes to computer applications. Graphics may look more attractive, but abstracted interfaces (text) are actually more efficient.

This document is not intended to be an exhaustive tutorial on how to use SPICE. I'm merely trying to show the interested user how to apply it to the analysis of simple circuits, as an alternative to proprietary (\$\$\$) and buggy programs. Once you learn the basics, there are other tutorials better suited to take you further. Using SPICE – a program originally intended to develop integrated circuits – to analyze some of the really simple circuits showcased here may seem a bit like cutting butter with a chain saw, but it works!

All options and examples have been tested on SPICE version 2g6 on both MS-DOS and Linux operating systems. As far as I know, I'm not using features specific to version 2g6, so these simple functions should work on most versions of SPICE.

7.2 History of SPICE

SPICE is a computer program designed to simulate analog electronic circuits. Its original intent was for the development of integrated circuits, from which it derived its name: **S**imulation **P**rogram with **I**ntegrated **C**ircuit **E**mphasis.

The origin of SPICE traces back to another circuit simulation program called CANCER. Developed by professor Ronald Rohrer of U.C. Berkeley along with some of his students in the late 1960's, CANCER continued to be improved through the early 1970's. When Rohrer left Berkeley, CANCER was re-written and re-named to SPICE, released as version 1 to the public domain in May of 1972. Version 2 of SPICE was released in 1975 (version 2g6 – the version used in this book – is a minor revision of this 1975 release). Instrumental in the decision to release SPICE as a public-domain computer program was professor Donald Pederson of Berkeley, who believed that all significant technical progress happens when information is freely shared. I for one thank him for his vision.

A major improvement came about in March of 1985 with version 3 of SPICE (also released under public domain). Written in the C language rather than FORTRAN, version 3 incorporated additional transistor types (the MESFET, for example), and switch elements. Version 3 also allowed the use of alphabetical node labels rather than only numbers. Instructions written for version 2 of SPICE should still run in version 3, though.

Despite the additional power of version 3, I have chosen to use version 2g6 throughout this book because it seems to be the easiest version to acquire and run on different computer systems.

7.3 Fundamentals of SPICE programming

Programming a circuit simulation with SPICE is much like programming in any other computer language: you must type the commands as text in a file, save that file to the computer's hard drive, and then process the contents of that file with a program (compiler or interpreter) that understands such commands.

In an interpreted computer language, the computer holds a special program called an *interpreter* that translates the program you wrote (the so-called *source file*) into the computer's own language, on the fly, as it's being executed:

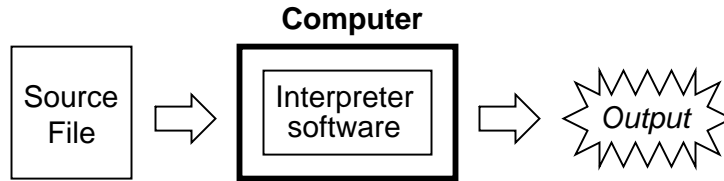

In a compiled computer language, the program you wrote is translated all at once into the computer's own language by a special program called a *compiler*. After the program you've written has been "compiled," the resulting *executable* file needs no further translation to be understood directly by the computer. It can now be "run" on a computer whether or not compiler software has been installed on that computer:

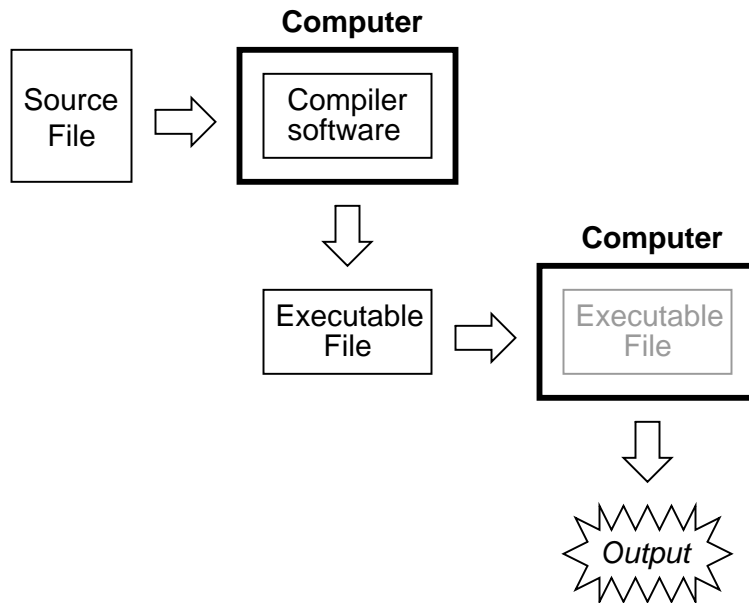

SPICE is an interpreted language. In order for a computer to be able to understand the SPICE instructions you type, it must have the SPICE program (interpreter) installed:

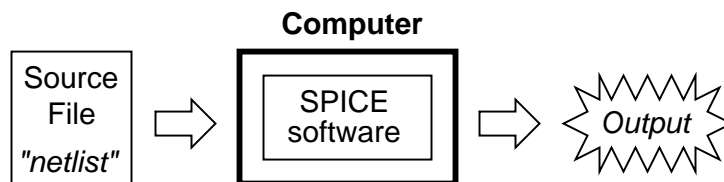

SPICE source files are commonly referred to as "netlists," although they are sometimes known as "decks" with each line in the file being called a "card." Cute, don't you think? Netlists are created by a person like yourself typing instructions line-by-line using a word processor or text editor. Text editors are much preferred over word processors for any type of computer programming, as

they produce pure ASCII text with no special embedded codes for text highlighting (like *italic* or **boldface** fonts), which are uninterpretable by interpreter and compiler software.

As in general programming, the source file you create for SPICE must follow certain conventions of programming. It is a computer language in itself, albeit a simple one. Having programmed in BASIC and C/C++, and having some experience reading PASCAL and FORTRAN programs, it is my opinion that the language of SPICE is much simpler than any of these. It is about the same complexity as a markup language such as HTML, perhaps less so.

There is a cycle of steps to be followed in using SPICE to analyze a circuit. The cycle starts when you first invoke the text editing program and make your first draft of the netlist. The next step is to run SPICE on that new netlist and see what the results are. If you are a novice user of SPICE, your first attempts at creating a good netlist will be fraught with small errors of syntax. Don't worry – as every computer programmer knows, proficiency comes with lots of practice. If your trial run produces error messages or results that are obviously incorrect, you need to re-invoke the text editing program and modify the netlist. After modifying the netlist, you need to run SPICE again and check the results. The sequence, then, looks something like this:

- Compose a new netlist with a text editing program. Save that netlist to a file with a name of your choice.
- Run SPICE on that netlist and observe the results.
- If the results contain errors, start up the text editing program again and modify the netlist.
- Run SPICE again and observe the new results.
- If there are still errors in the output of SPICE, re-edit the netlist again with the text editing program. Repeat this cycle of edit/run as many times as necessary until you are getting the desired results.
- Once you've "debugged" your netlist and are getting good results, run SPICE again, only this time redirecting the output to a new file instead of just observing it on the computer screen.
- Start up a text editing program *or* a word processor program and open the SPICE output file you just created. Modify that file to suit your formatting needs and either save those changes to disk and/or print them out on paper.

To "run" a SPICE "program," you need to type in a command at a terminal prompt interface, such as that found in MS-DOS, UNIX, or the MS-Windows DOS prompt option:

```
spice < example.cir
```

The word "spice" invokes the SPICE interpreting program (providing that the SPICE software has been installed on the computer!), the "<" symbol redirects the contents of the source file to the SPICE interpreter, and `example.cir` is the name of the source file for this circuit example. The file extension ".cir" is not mandatory; I have seen ".inp" (for "input") and just plain ".txt" work well, too. It will even work when the netlist file has no extension. SPICE doesn't care what you name it, so long as it has a name compatible with the filesystem of your computer (for old MS-DOS machines, for example, the filename must be no more than 8 characters in length, with a 3 character extension, and no spaces or other non-alphanumeric characters).

When this command is typed in, SPICE will read the contents of the `example.cir` file, analyze the circuit specified by that file, and send a text report to the computer terminal's standard output (usually the screen, where you can see it scroll by). A typical SPICE output is several screens worth of information, so you might want to look it over with a slight modification of the command:

```
spice < example.cir | more
```

This alternative "pipes" the text output of SPICE to the "more" utility, which allows only one page to be displayed at a time. What this means (in English) is that the text output of SPICE is halted after one screen-full, and waits until the user presses a keyboard key to display the next screen-full of text. If you're just testing your example circuit file and want to check for any errors, this is a good way to do it.

```
spice < example.cir > example.txt
```

This second alternative (above) redirects the text output of SPICE to another file, called `example.txt`, where it can be viewed or printed. This option corresponds to the last step in the development cycle listed earlier. It is recommended by this author that you use this technique of "redirection" to a text file only after you've proven your example circuit netlist to work well, so that you don't waste time invoking a text editor just to see the output during the stages of "debugging."

Once you have a SPICE output stored in a `.txt` file, you can use a text editor or (better yet!) a word processor to edit the output, deleting any unnecessary banners and messages, even specifying alternative fonts to highlight the headings and/or data for a more polished appearance. Then, of course, you can print the output to paper if you so desire. Being that the direct SPICE output is plain ASCII text, such a file will be universally interpretable on any computer whether SPICE is installed on it or not. Also, the plain text format ensures that the file will be very small compared to the graphic screen-shot files generated by "point-and-click" simulators.

The netlist file format required by SPICE is quite simple. A netlist file is nothing more than a plain ASCII text file containing multiple lines of text, each line describing either a circuit component or special SPICE command. Circuit architecture is specified by assigning numbers to each component's connection points in each line, connections between components designated by common numbers. Examine the following example circuit diagram and its corresponding SPICE file. Please bear in mind that the circuit diagram exists only to make the simulation easier for human beings to understand. SPICE only understands netlists:

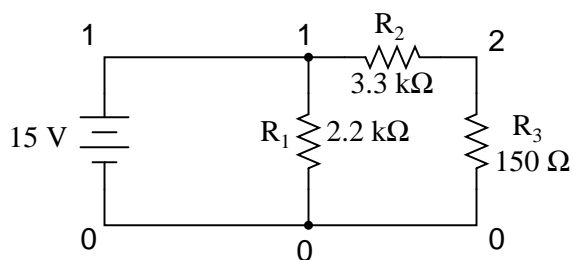

```
Example netlist
v1 1 0 dc 15
```



```

r1 1 0 2.2k
r2 1 2 3.3k
r3 2 0 150
.end

```

Each line of the source file shown above is explained here:

- **v1** represents the battery (voltage source 1), positive terminal numbered 1, negative terminal numbered 0, with a DC voltage output of 15 volts.
- **r1** represents resistor R_1 in the diagram, connected between points 1 and 0, with a value of 2.2 k Ω .
- **r2** represents resistor R_2 in the diagram, connected between points 1 and 2, with a value of 3.3 k Ω .
- **r3** represents resistor R_3 in the diagram, connected between points 2 and 0, with a value of 150 k Ω .

Electrically common points (or "nodes") in a SPICE circuit description share common numbers, much in the same way that wires connecting common points in a large circuit typically share common wire labels.

To simulate this circuit, the user would type those six lines of text on a text editor and save them as a file with a unique name (such as `example.cir`). Once the netlist is composed and saved to a file, the user then processes that file with one of the command-line statements shown earlier (`spice < example.cir`), and will receive this text output on their computer's screen:

```

1*****10/10/99 ***** spice 2g.6 3/15/83 *****07:32:42*****
0example netlist
0****  input listing           temperature = 27.000 deg c
v1 1 0 dc 15
r1 1 0 2.2k
r2 1 2 3.3k
r3 2 0 150
.end
*****10/10/99 ***** spice 2g.6 3/15/83 *****07:32:42*****
0example netlist
0****  small signal bias solution  temperature = 27.000 deg c
node  voltage      node  voltage
( 1)  15.0000      ( 2)   0.6522
voltage source currents
name      current
v1        -1.117E-02
total power dissipation 1.67E-01 watts
job concluded
0          total job time           0.02
1*****10/10/99 ***** spice 2g.6 3/15/83 *****07:32:42*****

```

```
0****  input listing                temperature = 27.000 deg c
```

SPICE begins by printing the time, date, and version used at the top of the output. It then lists the input parameters (the lines of the source file), followed by a display of DC voltage readings from each node (reference number) to ground (always reference number 0). This is followed by a list of current readings through each voltage source (in this case there's only one, v1). Finally, the total power dissipation and computation time in seconds is printed.

All output values provided by SPICE are displayed in scientific notation.

The SPICE output listing shown above is a little verbose for most peoples' taste. For a final presentation, it might be nice to trim all the unnecessary text and leave only what matters. Here is a sample of that same output, redirected to a text file (`spice < example.cir > example.txt`), then trimmed down judiciously with a text editor for final presentation and printed:

```
example netlist
v1 1 0 dc 15
r1 1 0 2.2k
r2 1 2 3.3k
r3 2 0 150
.end

node    voltage    node    voltage
( 1)    15.0000    ( 2)    0.6522

voltage source currents
name      current
v1        -1.117E-02

total power dissipation 1.67E-01 watts
```

One of the very nice things about SPICE is that both input and output formats are plain-text, which is the most universal and easy-to-edit electronic format around. Practically *any* computer will be able to edit and display this format, even if the SPICE program itself is not resident on that computer. If the user desires, he or she is free to use the advanced capabilities of word processing programs to make the output look fancier. Comments can even be inserted between lines of the output for further clarity to the reader.

7.4 The command-line interface

If you've used DOS or UNIX operating systems before in a command-line shell environment, you may wonder why we have to use the "<" symbol between the word "spice" and the name of the netlist file to be interpreted. Why not just enter the file name as the first argument to the command "spice" as we do when we invoke the text editor? The answer is that SPICE has the option of an *interactive* mode, whereby each line of the netlist can be interpreted as it is entered through the computer's Standard Input (stdin). If you simply type "spice" at the prompt and press **[Enter]**, SPICE will begin to interpret anything you type in to it (live).

For most applications, it's nice to save your netlist work in a separate file and then let SPICE interpret that file when you're ready. This is the way I encourage SPICE to be used, and so this is the way it's presented in this lesson. In order to use SPICE this way in a command-line environment, we need to use the "<" redirection symbol to direct the contents of your netlist file to Standard Input (stdin), which SPICE can then process.

7.5 Circuit components

Remember that this tutorial is not exhaustive by any means, and that all descriptions for elements in the SPICE language are documented here in condensed form. SPICE is a very capable piece of software with lots of options, and I'm only going to document a few of them.

All components in a SPICE source file are primarily identified by the first letter in each respective line. Characters following the identifying letter are used to distinguish one component of a certain type from another of the same type (r1, r2, r3, rload, rpullup, etc.), and need not follow any particular naming convention, so long as no more than eight characters are used in both the component identifying letter and the distinguishing name.

For example, suppose you were simulating a digital circuit with "pullup" and "pulldown" resistors. The name `rpullup` would be valid because it is seven characters long. The name `rpulldown`, however, is nine characters long. This may cause problems when SPICE interprets the netlist.

You can actually get away with component names in excess of eight total characters if there are no other similarly-named components in the source file. SPICE only pays attention to the first eight characters of the first field in each line, so `rpulldown` is actually interpreted as `rpulldow` with the "n" at the end being ignored. Therefore, any other resistor having the first eight characters in its first field will be seen by SPICE as the same resistor, defined twice, which will cause an error (i.e. `rpulldown1` and `rpulldown2` would be interpreted as the same name, `rpulldow`).

It should also be noted that SPICE ignores character case, so `r1` and `R1` are interpreted by SPICE as one and the same.

SPICE allows the use of metric prefixes in specifying component values, which is a very handy feature. However, the prefix convention used by SPICE differs somewhat from standard metric symbols, primarily due to the fact that netlists are restricted to standard ASCII characters (ruling out Greek letters such as μ for the prefix "micro") and that SPICE is case-insensitive, so "m" (which is the standard symbol for "milli") and "M" (which is the standard symbol for "Mega") are interpreted identically. Here are a few examples of prefixes used in SPICE netlists:

```
r1 1 0 2t (Resistor R1, 2t = 2 Tera-ohms = 2 TΩ)
r2 1 0 4g (Resistor R2, 4g = 4 Giga-ohms = 4 GΩ)
r3 1 0 47meg (Resistor R3, 47meg = 47 Mega-ohms = 47 MΩ)
r4 1 0 3.3k (Resistor R4, 3.3k = 3.3 kilo-ohms = 3.3 kΩ)
r5 1 0 55m (Resistor R5, 55m = 55 milli-ohms = 55 mΩ)
r6 1 0 10u (Resistor R6, 10u = 10 micro-ohms = 10 μΩ)
r7 1 0 30n (Resistor R7, 30n = 30 nano-ohms = 30 nΩ)
r8 1 0 5p (Resistor R8, 5p = 5 pico-ohms = 5 pΩ)
r9 1 0 250f (Resistor R9, 250f = 250 femto-ohms = 250 fΩ)
```

Scientific notation is also allowed in specifying component values. For example:

```
r10 1 0 4.7e3 (Resistor R10, 4.7e3 = 4.7 x 103 ohms = 4.7 kilo-ohms = 4.7 kΩ)
r11 1 0 1e-12 (Resistor R11, 1e-12 = 1 x 10-12 ohms = 1 pico-ohm = 1 pΩ)
```

The unit (ohms, volts, farads, henrys, etc.) is automatically determined by the type of component being specified. SPICE "knows" that all of the above examples are "ohms" because they are all resistors (r1, r2, r3, . . .). If they were capacitors, the values would be interpreted as "farads," if inductors, then "henrys," etc.

7.5.1 Passive components

CAPACITORS:

General form: c[name] [node1] [node2] [value] ic=[initial voltage]

Example 1: c1 12 33 10u

Example 2: c1 12 33 10u ic=3.5

Comments: The "initial condition" (ic=) variable is the capacitor's voltage in units of *volts* at the start of DC analysis. It is an optional value, with the starting voltage assumed to be zero if unspecified. Starting current values for capacitors are interpreted by SPICE only if the .tran analysis option is invoked (with the "uic" option).

INDUCTORS:

General form: l[name] [node1] [node2] [value] ic=[initial current]

Example 1: l1 12 33 133m

Example 2: l1 12 33 133m ic=12.7m

Comments: The "initial condition" (ic=) variable is the inductor's current in units of *amps* at the start of DC analysis. It is an optional value, with the starting current assumed to be zero if unspecified. Starting current values for inductors are interpreted by SPICE only if the .tran analysis option is invoked.

INDUCTOR COUPLING (transformers):

General form: k[name] l[name] l[name] [coupling factor]

Example 1: k1 l1 l2 0.999

Comments: SPICE will only allow coupling factor values between 0 and 1 (non-inclusive), with 0 representing no coupling and 1 representing perfect coupling. The order of specifying coupled inductors (l1, l2 or l2, l1) is irrelevant.

RESISTORS:

General form: r[name] [node1] [node2] [value]

Example: rload 23 15 3.3k

Comments: In case you were wondering, there is no declaration of resistor power dissipation rating in SPICE. All components are assumed to be indestructible. If only real life were this forgiving!

7.5.2 Active components

All semiconductor components must have their electrical characteristics described in a line starting with the word ".model", which tells SPICE exactly how the device will behave. Whatever parameters are not explicitly defined in the .model card will default to values pre-programmed in SPICE. However, the .model card *must* be included, and at least specify the model name and device type (d, npn, pnp, njf, pjf, nmos, or pmos).

DIODES:

General form: d[name] [anode] [cathode] [model]

Example: d1 1 2 mod1

DIODE MODELS:

General form: .model [modelname] d [parmtr1=x] [parmtr2=x] . . .

Example: .model mod1 d

Example: .model mod2 d vj=0.65 rs=1.3

Parameter definitions:

is = saturation current in amps

rs = junction resistance in ohms

n = emission coefficient (unitless)

tt = transit time in seconds

cjo = zero-bias junction capacitance in farads

vj = junction potential in volts

m = grading coefficient (unitless)

eg = activation energy in electron-volts

xTi = saturation-current temperature exponent (unitless)

kf = flicker noise coefficient (unitless)

af = flicker noise exponent (unitless)

fc = forward-bias depletion capacitance coefficient (unitless)

bv = reverse breakdown voltage in volts

ibv = current at breakdown voltage in amps

Comments: The model name *must* begin with a letter, not a number. If you plan to specify a model for a 1N4003 rectifying diode, for instance, you cannot use "1n4003" for the model name. An alternative might be "m1n4003" instead.

TRANSISTORS (bipolar junction – BJT):

General form: q[name] [collector] [base] [emitter] [model]

Example: q1 2 3 0 mod1

BJT TRANSISTOR MODELS:

General form: .model [modelname] [nnp or pnp] [parmtr1=x] . . .

Example: .model mod1 pnp

Example: .model mod2 npn bf=75 is=1e-14

The model examples shown above are very nonspecific. To accurately model real-life transistors, more parameters are necessary. Take these two examples, for the popular 2N2222 and 2N2907 transistors (the "+" characters represent line-continuation marks in SPICE, when you wish to break a single line (card) into two or more separate lines on your text editor:

Example: .model m2n2222 npn is=19f bf=150 vaf=100 ikf=.18

```

+           ise=50p ne=2.5 br=7.5 var=6.4 ikr=12m
+           isc=8.7p nc=1.2 rb=50 re=0.4 rc=0.4 cje=26p
+           tf=0.5n cjc=11p tr=7n xtb=1.5 kf=0.032f af=1
Example:    .model m2n2907 pnp is=1.1p bf=200 nf=1.2 vaf=50
+           ikf=0.1 ise=13p ne=1.9 br=6 rc=0.6 cje=23p
+           vje=0.85 mje=1.25 tf=0.5n cjc=19p vjc=0.5
+           mjc=0.2 tr=34n xtb=1.5

```

Parameter definitions:

is = transport saturation current in amps
bf = ideal maximum forward Beta (unitless)
nf = forward current emission coefficient (unitless)
vaf = forward Early voltage in volts
ikf = corner for forward Beta high-current rolloff in amps
ise = B-E leakage saturation current in amps
ne = B-E leakage emission coefficient (unitless)
br = ideal maximum reverse Beta (unitless)
nr = reverse current emission coefficient (unitless)
bar = reverse Early voltage in volts
ikrikr = corner for reverse Beta high-current rolloff in amps
iscisc = B-C leakage saturation current in amps
nc = B-C leakage emission coefficient (unitless)
rb = zero bias base resistance in ohms
irb = current for base resistance halfway value in amps
rbm = minimum base resistance at high currents in ohms
re = emitter resistance in ohms
rc = collector resistance in ohms
cje = B-E zero-bias depletion capacitance in farads
vje = B-E built-in potential in volts
mje = B-E junction exponential factor (unitless)
tf = ideal forward transit time (seconds)
xtf = coefficient for bias dependence of transit time (unitless)
vtf = B-C voltage dependence on transit time, in volts
itf = high-current parameter effect on transit time, in amps
ptf = excess phase at $f=1/(\text{transit time})^2(\pi)$ Hz, in degrees
cjc = B-C zero-bias depletion capacitance in farads
vjc = B-C built-in potential in volts
mjc = B-C junction exponential factor (unitless)
xjcj = B-C depletion capacitance fraction connected in base node (unitless)
tr = ideal reverse transit time in seconds
cjs = zero-bias collector-substrate capacitance in farads
vjs = substrate junction built-in potential in volts
mjs = substrate junction exponential factor (unitless)
xtb = forward/reverse Beta temperature exponent
eg = energy gap for temperature effect on transport saturation current in electron-volts
xti = temperature exponent for effect on transport saturation current (unitless)
kf = flicker noise coefficient (unitless)

af = flicker noise exponent (unitless)
 fc = forward-bias depletion capacitance formula coefficient (unitless)

Comments: Just as with diodes, the model name given for a particular transistor type *must* begin with a letter, not a number. That's why the examples given above for the 2N2222 and 2N2907 types of BJTs are named "m2n2222" and "m2n2907" respectively.

As you can see, SPICE allows for very detailed specification of transistor properties. Many of the properties listed above are well beyond the scope and interest of the beginning electronics student, and aren't even useful apart from knowing the equations SPICE uses to model BJT transistors. For those interested in learning more about transistor modeling in SPICE, consult other books, such as Andrei Vladimirescu's *The Spice Book* (ISBN 0-471-60926-9).

TRANSISTORS (junction field-effect – JFET):

General form: j[name] [drain] [gate] [source] [model]

Example: j1 2 3 0 mod1

JFET TRANSISTOR MODELS:

General form: .model [modelname] [njf or pjf] [parmtr1=x] . . .

Example: .model mod1 pjf

Example: .model mod2 njf lambda=1e-5 pb=0.75

Parameter definitions:

vto = threshold voltage in volts
 beta = transconductance parameter in amps/volts²
 lambda = channel length modulation parameter in units of 1/volts
 rd = drain resistance in ohms
 rs = source resistance in ohms
 cgs = zero-bias G-S junction capacitance in farads
 cgd = zero-bias G-D junction capacitance in farads
 pb = gate junction potential in volts
 is = gate junction saturation current in amps
 kf = flicker noise coefficient (unitless)
 af = flicker noise exponent (unitless)
 fc = forward-bias depletion capacitance coefficient (unitless)

TRANSISTORS (insulated-gate field-effect – IGFET or MOSFET):

General form: m[name] [drain] [gate] [source] [substrate] [model]

Example: m1 2 3 0 0 mod1

MOSFET TRANSISTOR MODELS:

General form: .model [modelname] [nmos or pmos] [parmtr1=x] . . .

Example: .model mod1 pmos

Example: .model mod2 nmos level=2 phi=0.65 rd=1.5

Example: .model mod3 nmos vto=-1 (depletion)

Example: .model mod4 nmos vto=1 (enhancement)

Example: .model mod5 pmos vto=1 (depletion)

Example: .model mod6 pmos vto=-1 (enhancement)

Comments: In order to distinguish between enhancement mode and depletion-mode (also known as depletion-enhancement mode) transistors, the model parameter "vto" (zero-bias threshold voltage) must be specified. Its default value is zero, but a positive value (+1 volts, for example)

on a P-channel transistor or a negative value (-1 volts) on an N-channel transistor will specify that transistor to be a *depletion* (otherwise known as *depletion-enhancement*) mode device. Conversely, a negative value on a P-channel transistor or a positive value on an N-channel transistor will specify that transistor to be an *enhancement mode* device.

Remember that enhancement mode transistors are normally-off devices, and must be turned on by the application of gate voltage. Depletion-mode transistors are normally "on," but can be "pinched off" as well as enhanced to greater levels of drain current by applied gate voltage, hence the alternate designation of "depletion-enhancement" MOSFETs. The "vto" parameter specifies the threshold gate voltage for MOSFET conduction.

7.5.3 Sources

AC SINEWAVE VOLTAGE SOURCES (when using .ac card to specify frequency):

General form: v[name] [+node] [-node] ac [voltage] [phase] sin

Example 1: v1 1 0 ac 12 sin

Example 2: v1 1 0 ac 12 240 sin (12 V \angle 240°)

Comments: This method of specifying AC voltage sources works well if you're using multiple sources at different phase angles from each other, but all at the same frequency. If you need to specify sources at different frequencies in the same circuit, you must use the next method!

AC SINEWAVE VOLTAGE SOURCES (when NOT using .ac card to specify frequency):

General form: v[name] [+node] [-node] sin([offset] [voltage]
+ [freq] [delay] [damping factor])

Example 1: v1 1 0 sin(0 12 60 0 0)

Parameter definitions:

offset = DC bias voltage, offsetting the AC waveform by a specified voltage.

voltage = peak, or crest, AC voltage value for the waveform.

freq = frequency in Hertz.

delay = time delay, or phase offset for the waveform, in seconds.

damping factor = a figure used to create waveforms of decaying amplitude.

Comments: This method of specifying AC voltage sources works well if you're using multiple sources at different frequencies from each other. Representing phase shift is tricky, though, necessitating the use of the *delay* factor.

DC VOLTAGE SOURCES (when using .dc card to specify voltage):

General form: v[name] [+node] [-node] dc

Example 1: v1 1 0 dc

Comments: If you wish to have SPICE output voltages *not* in reference to node 0, you must use the .dc analysis option, and to use this option you must specify at least one of your DC sources in this manner.

DC VOLTAGE SOURCES (when NOT using .dc card to specify voltage):

General form: v[name] [+node] [-node] dc [voltage]

Example 1: v1 1 0 dc 12

Comments: Nothing noteworthy here!

PULSE VOLTAGE SOURCES

General form: v[name] [+node] [-node] pulse ([i] [p] [td] [tr]
+ [tf] [pw] [pd])

Parameter definitions:

i = initial value

p = pulse value

td = delay time (all time parameters in units of seconds)

tr = rise time

tf = fall time

pw = pulse width

pd = period

Example 1: v1 1 0 pulse (-3 3 0 0 0 10m 20m)

Comments: Example 1 is a perfect square wave oscillating between -3 and +3 volts, with zero rise and fall times, a 20 millisecond period, and a 50 percent duty cycle (+3 volts for 10 ms, then -3 volts for 10 ms).

AC SINEWAVE CURRENT SOURCES (when using .ac card to specify frequency):

General form: i[name] [+node] [-node] ac [current] [phase] sin

Example 1: i1 1 0 ac 3 sin (3 amps)

Example 2: i1 1 0 ac 1m 240 sin (1 mA \angle 240°)

Comments: The same comments apply here (and in the next example) as for AC voltage sources.

AC SINEWAVE CURRENT SOURCES (when NOT using .ac card to specify frequency):

General form: i[name] [+node] [-node] sin([offset]

+ [current] [freq] 0 0)

Example 1: i1 1 0 sin(0 1.5 60 0 0)

DC CURRENT SOURCES (when using .dc card to specify current):

General form: i[name] [+node] [-node] dc

Example 1: i1 1 0 dc

DC CURRENT SOURCES (when NOT using .dc card to specify current):

General form: i[name] [+node] [-node] dc [current]

Example 1: i1 1 0 dc 12

Comments: Even though the books all say that the first node given for the DC current source is the positive node, that's not what I've found to be in practice. In actuality, a DC current source in SPICE pushes current in the same direction as a voltage source (battery) would with its *negative* node specified first.

PULSE CURRENT SOURCES

General form: i[name] [+node] [-node] pulse ([i] [p] [td] [tr]
+ [tf] [pw] [pd])

Parameter definitions:

i = initial value

p = pulse value
 td = delay time
 tr = rise time
 tf = fall time
 pw = pulse width
 pd = period

Example 1: `i1 1 0 pulse (-3m 3m 0 0 0 17m 34m)`

Comments: Example 1 is a perfect square wave oscillating between -3 mA and +3 mA, with zero rise and fall times, a 34 millisecond period, and a 50 percent duty cycle (+3 mA for 17 ms, then -3 mA for 17 ms).

VOLTAGE SOURCES (dependent):

General form: `e[name] [out+node] [out-node] [in+node] [in-node]
 + [gain]`

Example 1: `e1 2 0 1 2 999k`

Comments: Dependent voltage sources are great to use for simulating operational amplifiers. Example 1 shows how such a source would be configured for use as a voltage follower, inverting input connected to output (node 2) for negative feedback, and the noninverting input coming in on node 1. The gain has been set to an arbitrarily high value of 999,000. One word of caution, though: SPICE does not recognize the input of a dependent source as being a load, so a voltage source tied only to the input of an independent voltage source will be interpreted as "open." See op-amp circuit examples for more details on this.

CURRENT SOURCES (dependent):

7.6 Analysis options

AC ANALYSIS:

General form: `.ac [curve] [points] [start] [final]`

Example 1: `.ac lin 1 1000 1000`

Comments: The [curve] field can be "lin" (linear), "dec" (decade), or "oct" (octave), specifying the (non)linearity of the frequency sweep. [points] specifies how many points within the frequency sweep to perform analyses at (for decade sweep, the number of points per decade; for octave, the number of points per octave). The [start] and [final] fields specify the starting and ending frequencies of the sweep, respectively. One final note: the "start" value cannot be zero!

DC ANALYSIS:

General form: `.dc [source] [start] [final] [increment]`

Example 1: `.dc vin 1.5 15 0.5`

Comments: The .dc card is necessary if you want to print or plot any voltage between two nonzero nodes. Otherwise, the default "small-signal" analysis only prints out the voltage between each nonzero node and node zero.

TRANSIENT ANALYSIS:

General form: `.tran [increment] [stop_time] [start_time]`

+ [comp_interval]

Example 1: .tran 1m 50m uic

Example 2: .tran .5m 32m 0 .01m

Comments: Example 1 has an increment time of 1 millisecond and a stop time of 50 milliseconds (when only two parameters are specified, they are *increment time* and *stop time*, respectively). Example 2 has an increment time of 0.5 milliseconds, a stop time of 32 milliseconds, a start time of 0 milliseconds (no delay on start), and a computation interval of 0.01 milliseconds.

Default value for start time is zero. Transient analysis *always* begins at time zero, but storage of data only takes place between start time and stop time. Data output interval is increment time, or (stop time - start time)/50, whichever is smallest. However, the computing interval variable can be used to force a computational interval smaller than either. For large total interval counts, the `itl5` variable in the `.options` card may be set to a higher number. The "uic" option tells SPICE to "use initial conditions."

PLOT OUTPUT:

General form: .plot [type] [output1] [output2] . . . [output n]

Example 1: .plot dc v(1,2) i(v2)

Example 2: .plot ac v(3,4) vp(3,4) i(v1) ip(v1)

Example 3: .plot tran v(4,5) i(v2)

Comments: SPICE can't handle more than eight data point requests on a single `.plot` or `.print` card. If requesting more than eight data points, use multiple cards!

Also, here's a major caveat when using SPICE version 3: if you're performing AC analysis and you ask SPICE to plot an AC voltage as in example #2, the `v(3,4)` command will only output the *real* component of a rectangular-form complex number! SPICE version 2 outputs the *polar* magnitude of a complex number: a much more meaningful quantity if only a single quantity is asked for. To coerce SPICE3 to give you polar magnitude, you will have to re-write the `.print` or `.plot` argument as such: `vm(3,4)`.

PRINT OUTPUT:

General form: .print [type] [output1] [output2] . . . [output n]

Example 1: .print dc v(1,2) i(v2)

Example 2: .print ac v(2,4) i(vinput) vp(2,3)

Example 3: .print tran v(4,5) i(v2)

Comments: SPICE can't handle more than eight data point requests on a single `.plot` or `.print` card. If requesting more than eight data points, use multiple cards!

FOURIER ANALYSIS:

General form: .four [freq] [output1] [output2] . . . [output n]

Example 1: .four 60 v(1,2)

Comments: The `.four` card relies on the `.tran` card being present somewhere in the deck, with the proper time periods for analysis of adequate cycles. Also, SPICE may "crash" if a `.plot` analysis isn't done along with the `.four` analysis, even if all `.tran` parameters are technically correct. Finally, the `.four` analysis option only works when the frequency of the AC source is specified in that source's card line, and *not* in an `.ac` analysis option line.

It helps to include a computation interval variable in the `.tran` card for better analysis precision. A Fourier analysis of the voltage or current specified is performed up to the 9th harmonic, with the [freq] specification being the fundamental, or starting frequency of the analysis spectrum.

MISCELLANEOUS:

```

General form:  .options [option1] [option2]
Example 1:     .options limpts=500
Example 2:     .options it15=0
Example 3:     .options method=gear
Example 4:     .options list
Example 5:     .options nopage
Example 6:     .options numdgt=6

```

Comments: There are lots of options that can be specified using this card. Perhaps the one most needed by beginning users of SPICE is the "limpts" setting. When running a simulation that requires more than 201 points to be printed or plotted, this calculation point limit must be increased or else SPICE will terminate analysis. The example given above (limpts=500) tells SPICE to allocate enough memory to handle at least 500 calculation points in whatever type of analysis is specified (DC, AC, or transient).

In example 2, we see an *iteration* variable (it15) being set to a value of 0. There are actually six different iteration variables available for user manipulation. They control the iteration cycle limits for solution of nonlinear equations. The variable it15 sets the maximum number of iterations for a transient analysis. Similar to the limpts variable, it15 usually needs to be set when a small computation interval has been specified on a .tran card. Setting it15 to a value of 0 turns off the limit entirely, allowing the computer infinite iteration cycles (infinite time) to compute the analysis. *Warning: this may result in long simulation times!*

Example 3 with "method=gear" sets the numerical integration method used by SPICE. The default is "trapezoid" rather than "gear," trapezoid being a simple geometric approximation of area under a curve found by slicing up the curve into trapezoids to approximate the shape. The "gear" method is based on second-order or better polynomial equations and is named after C.W. Gear (*Numerical Integration of Stiff Ordinary Equations*, Report 221, Department of Computer Science, University of Illinois, Urbana). The Gear method of integration is more demanding of the computer (computationally "expensive") and will sometimes give slightly different results from the trapezoid method.

The "list" option shown in example 4 gives a verbose summary of all circuit components and their respective values in the final output.

By default, SPICE will insert ASCII page-break control codes in the output to separate different sections of the analysis. Specifying the "nopage" option (example 5) will prevent such pagination.

The "numdgt" option shown in example 6 specifies the number of significant digits output when using one of the ".print" data output options. SPICE defaults at a precision of 4 significant digits.

WIDTH CONTROL:

```

General form:  .width in=[columns] out=[columns]
Example 1:     .width out=80

```

Comments: The .width card can be used to control the width of text output lines upon analysis. This is especially handy when plotting graphs with the .plot card. The default value is 120, which can cause problems on 80-character terminal displays unless set to 80 with this command.

7.7 Quirks

"Garbage in, garbage out."

Anonymous

SPICE is a very reliable piece of software, but it does have its little quirks that take some getting used to. By "quirk" I mean a demand placed upon the user to write the source file in a particular way in order for it to work without giving error messages. I do *not* mean any kind of fault with SPICE which would produce erroneous or misleading results: that would be more properly referred to as a "bug." Speaking of bugs, SPICE has a few of them as well.

Some (or all) of these quirks may be unique to SPICE version 2g6, which is the only version I've used extensively. They may have been fixed in later versions.

7.7.1 A good beginning

SPICE demands that the source file begin with something other than the first "card" in the circuit description "deck." This first character in the source file can be a linefeed, title line, or a comment: there just has to be *something* there before the first component-specifying line of the file. If not, SPICE will refuse to do an analysis at all, claiming that there is a serious error (such as improper node connections) in the "deck."

7.7.2 A good ending

SPICE demands that the `.end` line at the end of the source file not be terminated with a linefeed or carriage return character. In other words, when you finish typing "`.end`" you should not hit the **[Enter]** key on your keyboard. The cursor on your text editor should stop immediately to the right of the "d" after the "`.end`" and go no further. Failure to heed this quirk will result in a "*missing .end card*" error message at the end of the analysis output. The actual circuit analysis is not affected by this error, so I normally ignore the message. However, if you're looking to receive a "perfect" output, you must pay heed to this idiosyncrasy.

7.7.3 Must have a node 0

You are given much freedom in numbering circuit nodes, but you *must* have a node 0 somewhere in your netlist in order for SPICE to work. Node 0 is the default node for circuit ground, and it is the point of reference for all voltages specified at single node locations.

When simple DC analysis is performed by SPICE, the output will contain a listing of voltages at all non-zero nodes in the circuit. The point of reference (ground) for all these voltage readings is node 0. For example:

```
node    voltage    node    voltage
( 1)   15.0000   ( 2)    0.6522
```

In this analysis, there is a DC voltage of 15 volts between node 1 and ground (node 0), and a DC voltage of 0.6522 volts between node 2 and ground (node 0). In both these cases, the voltage polarity is negative at node 0 with reference to the other node (in other words, both nodes 1 and 2 are positive with respect to node 0).

7.7.4 Avoid open circuits

SPICE cannot handle open circuits of any kind. If your netlist specifies a circuit with an open voltage source, for example, SPICE will refuse to perform an analysis. A prime example of this type of error is found when "connecting" a voltage source to the input of a voltage-dependent source (used to simulate an operational amplifier). SPICE needs to see a complete path for current, so I usually tie a high-value resistor (call it `rbogus!`) across the voltage source to act as a minimal load.

7.7.5 Avoid certain component loops

SPICE cannot handle certain uninterrupted loops of components in a circuit, namely voltage sources and inductors. The following loops will cause SPICE to abort analysis:

Parallel inductors

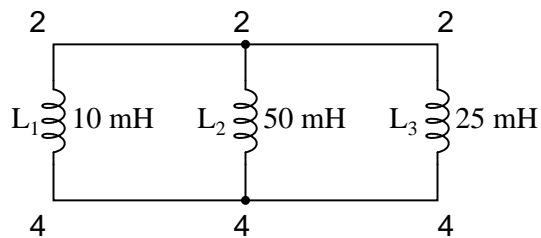

```
netlist
L1 2 4 10m
L2 2 4 50m
L3 2 4 25m
```

Voltage source / inductor loop

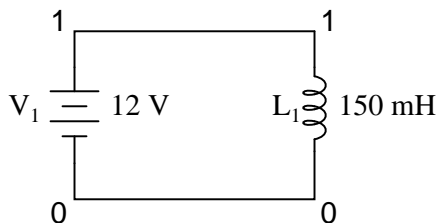

```
netlist
v1 1 0 dc 12
l1 1 0 150m
```

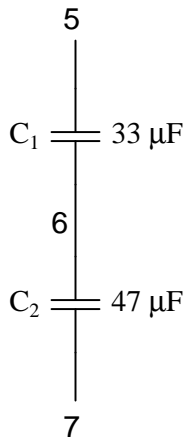
Series capacitors

```
netlist
c1 5 6 33u
c2 6 7 47u
```

The reason SPICE can't handle these conditions stems from the way it performs DC analysis: by treating all inductors as shorts and all capacitors as opens. Since short-circuits (0Ω) and open circuits (infinite resistance) either contain or generate mathematical infinitudes, a computer simply cannot deal with them, and so SPICE will discontinue analysis if any of these conditions occur.

In order to make these component configurations acceptable to SPICE, you must insert resistors of appropriate values into the appropriate places, eliminating the respective short-circuits and open-circuits. If a series resistor is required, choose a very low resistance value. Conversely, if a parallel resistor is required, choose a very high resistance value. For example:

To fix the parallel inductor problem, insert a very low-value resistor in series with each offending inductor.

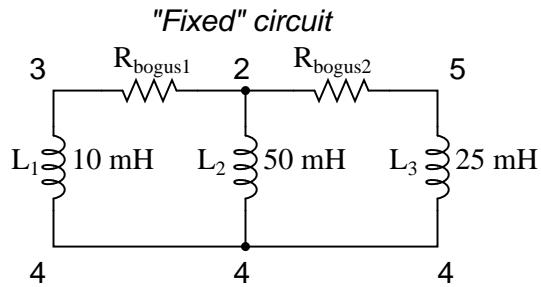
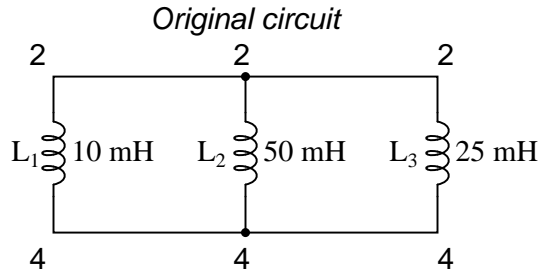

original netlist

```
l1 2 4 10m
l2 2 4 50m
l3 2 4 25m
```

fixed netlist

```
rbogus1 2 3 1e-12
rbogus2 2 5 1e-12
l1 3 4 10m
l2 2 4 50m
l3 5 4 25m
```

The extremely low-resistance resistors R_{bogus1} and R_{bogus2} (each one with a mere 1 pico-ohm of resistance) "break up" the direct parallel connections that existed between L_1 , L_2 , and L_3 . It is important to choose very low resistances here so that circuit operation is not substantially impacted by the "fix."

To fix the voltage source / inductor loop, insert a very low-value resistor in series with the two components.

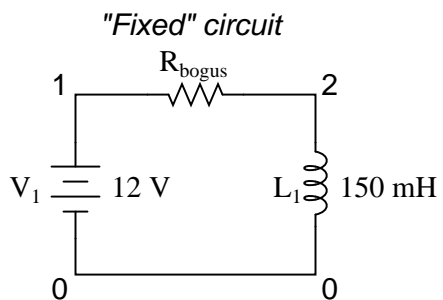
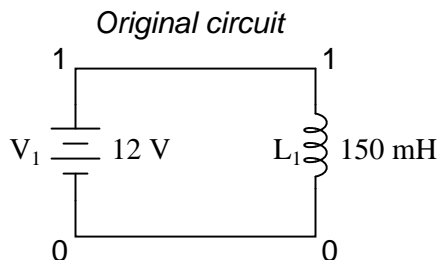

```
original netlist
v1 1 0 dc 12
l1 1 0 150m
```

```
fixed netlist
v1 1 0 dc 12
l1 2 0 150m
rbogus 1 2 1e-12
```

As in the previous example with parallel inductors, it is important to make the correction resistor (R_{bogus}) very low in resistance, so as to not substantially impact circuit operation.

To fix the series capacitor circuit, one of the capacitors must have a resistor shunting across it. SPICE requires a DC current path to each capacitor for analysis.

Original circuit

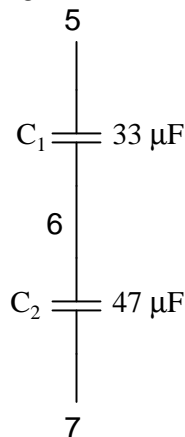

"Fixed" circuit

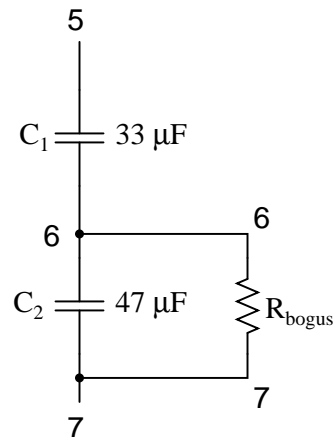

original netlist

```
c1 5 6 33u
c2 6 7 47u
```

fixed netlist

```
c1 5 6 33u
c2 6 7 47u
rbogus 6 7 9e12
```

The R_{bogus} value of 9 Tera-ohms provides a DC current path to C_1 (and around C_2) without substantially impacting the circuit's operation.

7.7.6 Current measurement

Although printing or plotting of voltage is quite easy in SPICE, the output of current values is a bit more difficult. Voltage measurements are specified by declaring the appropriate circuit nodes. For example, if we desire to know the voltage across a capacitor whose leads connect between nodes 4 and 7, we might make our `.print` statement look like this:

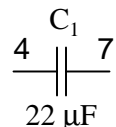

```
c1 4 7 22u
.print ac v(4,7)
```

However, if we wanted to have SPICE measure the *current* through that capacitor, it wouldn't be quite so easy. Currents in SPICE must be specified in relation to a voltage source, not any arbitrary component. For example:

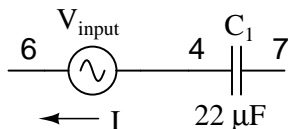

```
c1 4 7 22u
vinput 6 4 ac 1 sin
.print ac i(vinput)
```

This `.print` card instructs SPICE to print the current through voltage source V_{input} , which happens to be the same as the current through our capacitor between nodes 4 and 7. But what if there is no such voltage source in our circuit to reference for current measurement? One solution is to insert a shunt resistor into the circuit and measure voltage across it. In this case, I have chosen a shunt resistance value of $1\ \Omega$ to produce 1 volt per amp of current through C_1 :

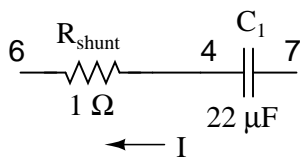

```
c1 4 7 22u
rshunt 6 4 1
.print ac v(6,4)
```

However, the insertion of an extra resistance into our circuit large enough to drop a meaningful voltage for the intended range of current might adversely affect things. A better solution for SPICE is this, although one would never seek such a current measurement solution in real life:

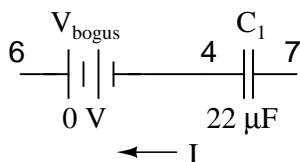

```
c1 4 7 22u
vbogus 6 4 dc 0
.print ac i(vbogus)
```

Inserting a "bogus" DC voltage source of zero volts doesn't affect circuit operation at all, yet it provides a convenient place for SPICE to take a current measurement. Interestingly enough, it doesn't matter that V_{bogus} is a DC source when we're looking to measure AC current! The fact that SPICE will output an AC current reading is determined by the "ac" specification in the `.print` card and nothing more.

It should also be noted that the way SPICE assigns a polarity to current measurements is a bit odd. Take the following circuit as an example:

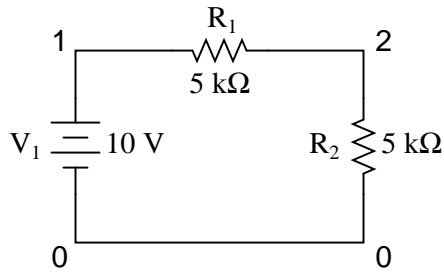

example

```
v1 1 0
r1 1 2 5k
r2 2 0 5k
.dc v1 10 10 1
.print dc i(v1)
.end
```

With 10 volts total voltage and 10 k Ω total resistance, you might expect SPICE to tell you there's going to be 1 mA (1e-03) of current through voltage source V_1 , but in actuality SPICE will output a figure of *negative* 1 mA (-1e-03)! SPICE regards current out of the negative end of a DC voltage source (the normal direction) to be a negative value of current rather than a positive value of current. There are times I'll throw in a "bogus" voltage source in a DC circuit like this simply to get SPICE to output a *positive* current value:

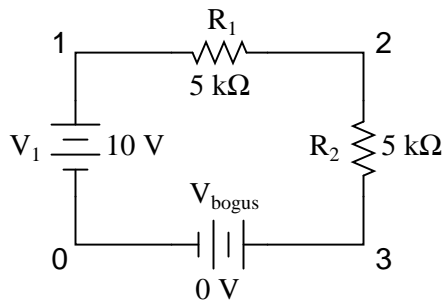

example

```
v1 1 0
r1 1 2 5k
r2 2 3 5k
vbogus 3 0 dc 0
.dc v1 10 10 1
.print dc i(vbogus)
.end
```

Notice how V_{bogus} is positioned so that the circuit current will enter its positive side (node 3) and exit its negative side (node 0). This orientation will ensure a positive output figure for circuit current.

7.7.7 Fourier analysis

When performing a Fourier (frequency-domain) analysis on a waveform, I have found it necessary to either print or plot the waveform using the `.print` or `.plot` cards, respectively. If you don't print or plot it, SPICE will pause for a moment during analysis and then abort the job after outputting the "initial transient solution."

Also, when analyzing a square wave produced by the "pulse" source function, you must give the waveform some finite rise and fall time, or else the Fourier analysis results will be incorrect. For some reason, a perfect square wave with zero rise/fall time produces significant levels of *even* harmonics according to SPICE's Fourier analysis option, which is not true for real square waves.

7.8 Example circuits and netlists

The following circuits are pre-tested netlists for SPICE 2g6, complete with short descriptions when necessary. Feel free to "copy" and "paste" any of the netlists to your own SPICE source file for analysis and/or modification. My goal here is twofold: to give practical examples of SPICE netlist design to further understanding of SPICE netlist syntax, and to show how simple and compact SPICE netlists can be in analyzing simple circuits.

All output listings for these examples have been "trimmed" of extraneous information, giving you the most succinct presentation of the SPICE output as possible. I do this primarily to save space on this document. Typical SPICE outputs contain lots of headers and summary information not necessarily germane to the task at hand. So don't be surprised when you run a simulation on your own and find that the output doesn't *exactly* look like what I have shown here!

7.8.1 Multiple-source DC resistor network, part 1

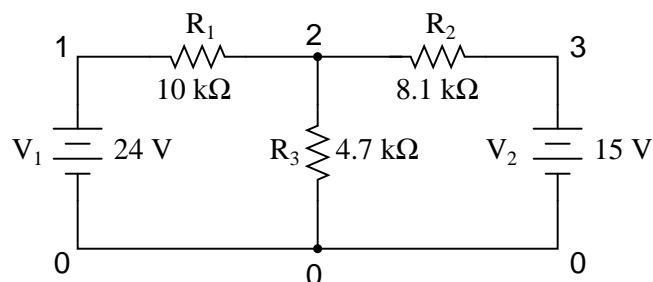

Without a `.dc` card and a `.print` or `.plot` card, the output for this netlist will only display voltages for nodes 1, 2, and 3 (with reference to node 0, of course).

Netlist:

```
Multiple dc sources
v1 1 0 dc 24
v2 3 0 dc 15
r1 1 2 10k
r2 2 3 8.1k
r3 2 0 4.7k
```

```
.end
```

Output:

```
node   voltage   node   voltage   node   voltage
( 1)   24.0000   ( 2)   9.7470   ( 3)   15.0000
```

```
voltage source currents
```

```
name      current
v1        -1.425E-03
v2        -6.485E-04
```

```
total power dissipation 4.39E-02 watts
```

7.8.2 Multiple-source DC resistor network, part 2

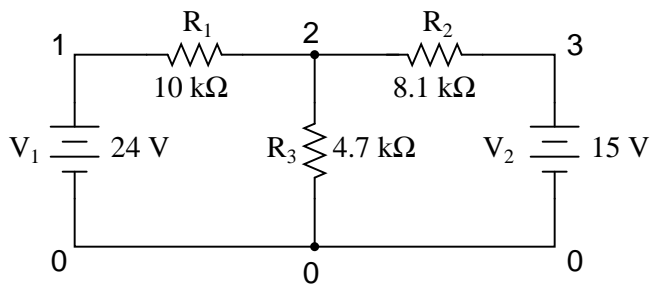

By adding a `.dc` analysis card and specifying source V_1 from 24 volts to 24 volts in 1 step (in other words, 24 volts steady), we can use the `.print` card analysis to print out voltages between any two points we desire. Oddly enough, when the `.dc` analysis option is invoked, the default voltage printouts for each node (to ground) disappears, so we end up having to explicitly specify them in the `.print` card to see them at all.

Netlist:

```
Multiple dc sources
v1 1 0
v2 3 0 15
r1 1 2 10k
r2 2 3 8.1k
r3 2 0 4.7k
.dc v1 24 24 1
.print dc v(1) v(2) v(3) v(1,2) v(2,3)
.end
```

Output:

```
v1      v(1)      v(2)      v(3)      v(1,2)      v(2,3)
2.400E+01  2.400E+01  9.747E+00  1.500E+01  1.425E+01  -5.253E+00
```

7.8.3 RC time-constant circuit

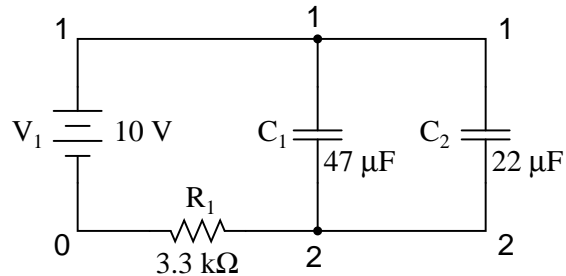

For DC analysis, the initial conditions of any reactive component (C or L) must be specified (voltage for capacitors, current for inductors). This is provided by the last data field of each capacitor card ($ic=0$). To perform a DC analysis, the `.tran` ("transient") analysis option must be specified, with the first data field specifying time increment in seconds, the second specifying total analysis timespan in seconds, and the "uic" telling it to "use initial conditions" when analyzing.

Netlist:

```
RC time delay circuit
v1 1 0 dc 10
c1 1 2 47u ic=0
c2 1 2 22u ic=0
r1 2 0 3.3k
.tran .05 1 uic
.print tran v(1,2)
.end
```

Output:

time	v(1,2)
0.000E+00	7.701E-06
5.000E-02	1.967E+00
1.000E-01	3.551E+00
1.500E-01	4.824E+00
2.000E-01	5.844E+00
2.500E-01	6.664E+00
3.000E-01	7.322E+00
3.500E-01	7.851E+00
4.000E-01	8.274E+00
4.500E-01	8.615E+00
5.000E-01	8.888E+00
5.500E-01	9.107E+00
6.000E-01	9.283E+00
6.500E-01	9.425E+00
7.000E-01	9.538E+00
7.500E-01	9.629E+00
8.000E-01	9.702E+00

```

8.500E-01    9.761E+00
9.000E-01    9.808E+00
9.500E-01    9.846E+00
1.000E+00    9.877E+00

```

7.8.4 Plotting and analyzing a simple AC sinewave voltage

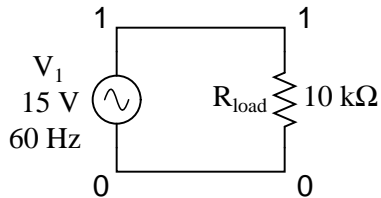

This exercise does show the proper setup for plotting instantaneous values of a sine-wave voltage source with the `.plot` function (as a *transient* analysis). Not surprisingly, the Fourier analysis in this deck also requires the `.tran` (transient) analysis option to be specified over a suitable time range. The time range in this particular deck allows for a Fourier analysis with rather poor accuracy. The more cycles of the fundamental frequency that the transient analysis is performed over, the more precise the Fourier analysis will be. This is not a quirk of SPICE, but rather a basic principle of waveforms.

Netlist:

```

v1 1 0 sin(0 15 60 0 0)
rload 1 0 10k
* change tran card to the following for better Fourier precision
* .tran 1m 30m .01m      and include .options card:
* .options itl5=30000
.tran 1m 30m
.plot tran v(1)
.four 60 v(1)
.end

```

Output:

time	v(1)	-2.000E+01	-1.000E+01	0.000E+00	1.000E+01
0.000E+00	0.000E+00	.	.	*	.
1.000E-03	5.487E+00	.	.	.	*
2.000E-03	1.025E+01	.	.	.	*
3.000E-03	1.350E+01	.	.	.	*
4.000E-03	1.488E+01	.	.	.	*
5.000E-03	1.425E+01	.	.	.	*
6.000E-03	1.150E+01	.	.	.	*
7.000E-03	7.184E+00	.	.	.	*
8.000E-03	1.879E+00	.	.	.	*
9.000E-03	-3.714E+00	.	.	*	.

```

1.000E-02 -8.762E+00 . . * . . .
1.100E-02 -1.265E+01 . * . . . .
1.200E-02 -1.466E+01 . * . . . .
1.300E-02 -1.465E+01 . * . . . .
1.400E-02 -1.265E+01 . * . . . .
1.500E-02 -8.769E+00 . . * . . .
1.600E-02 -3.709E+00 . . * . . .
1.700E-02 1.876E+00 . . . * . .
1.800E-02 7.191E+00 . . . * . .
1.900E-02 1.149E+01 . . . . * .
2.000E-02 1.425E+01 . . . . * .
2.100E-02 1.489E+01 . . . . * .
2.200E-02 1.349E+01 . . . . * .
2.300E-02 1.026E+01 . . . . * .
2.400E-02 5.491E+00 . . . . * .
2.500E-02 1.553E-03 . . . * . .
2.600E-02 -5.514E+00 . . * . . .
2.700E-02 -1.022E+01 . . * . . .
2.800E-02 -1.349E+01 . * . . . .
2.900E-02 -1.495E+01 . * . . . .
3.000E-02 -1.427E+01 . * . . . .
-----

```

fourier components of transient response v(1)

dc component = -1.885E-03

harmonic no	frequency (hz)	fourier component	normalized component	phase (deg)	normalized phase (deg)
1	6.000E+01	1.494E+01	1.000000	-71.998	0.000
2	1.200E+02	1.886E-02	0.001262	-50.162	21.836
3	1.800E+02	1.346E-03	0.000090	102.674	174.671
4	2.400E+02	1.799E-02	0.001204	-10.866	61.132
5	3.000E+02	3.604E-03	0.000241	160.923	232.921
6	3.600E+02	5.642E-03	0.000378	-176.247	-104.250
7	4.200E+02	2.095E-03	0.000140	122.661	194.658
8	4.800E+02	4.574E-03	0.000306	-143.754	-71.757
9	5.400E+02	4.896E-03	0.000328	-129.418	-57.420

total harmonic distortion = 0.186350 percent

7.8.5 Simple AC resistor-capacitor circuit

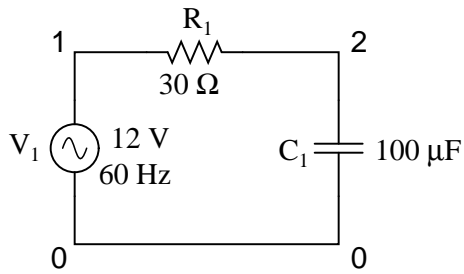

The `.ac` card specifies the points of ac analysis from 60Hz to 60Hz, at a single point. This card, of course, is a bit more useful for multi-frequency analysis, where a range of frequencies can be analyzed in steps. The `.print` card outputs the AC voltage between nodes 1 and 2, and the AC voltage between node 2 and ground.

Netlist:

```
Demo of a simple AC circuit
v1 1 0 ac 12 sin
r1 1 2 30
c1 2 0 100u
.ac lin 1 60 60
.print ac v(1,2) v(2)
.end
```

Output:

freq	v(1,2)	v(2)
6.000E+01	8.990E+00	7.949E+00

7.8.6 Low-pass filter

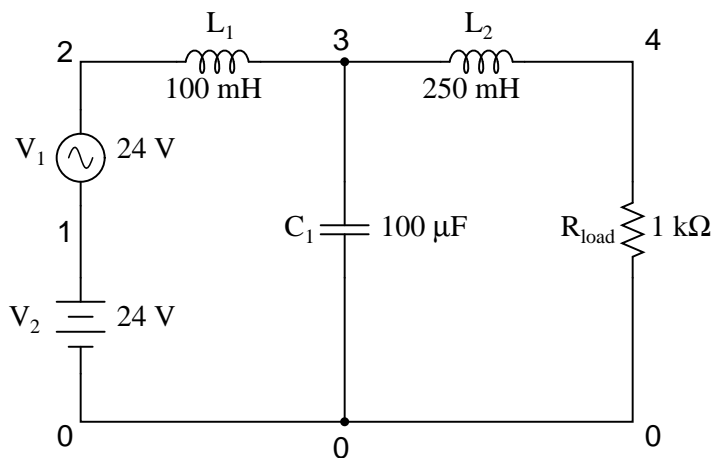

This low-pass filter blocks AC and passes DC to the R_{load} resistor. Typical of a filter used to suppress ripple from a rectifier circuit, it actually has a resonant frequency, technically making it a band-pass filter. However, it works well anyway to pass DC and block the high-frequency harmonics generated by the AC-to-DC rectification process. Its performance is measured with an AC source sweeping from 500 Hz to 15 kHz. If desired, the `.print` card can be substituted or supplemented with a `.plot` card to show AC voltage at node 4 graphically.

Netlist:

```
Lowpass filter
v1 2 1 ac 24 sin
v2 1 0 dc 24
rload 4 0 1k
l1 2 3 100m
l2 3 4 250m
c1 3 0 100u
.ac lin 30 500 15k
.print ac v(4)
.plot ac v(4)
.end
```

freq	v(4)
5.000E+02	1.935E-01
1.000E+03	3.275E-02
1.500E+03	1.057E-02
2.000E+03	4.614E-03
2.500E+03	2.402E-03
3.000E+03	1.403E-03
3.500E+03	8.884E-04
4.000E+03	5.973E-04
4.500E+03	4.206E-04
5.000E+03	3.072E-04
5.500E+03	2.311E-04
6.000E+03	1.782E-04
6.500E+03	1.403E-04
7.000E+03	1.124E-04
7.500E+03	9.141E-05
8.000E+03	7.536E-05
8.500E+03	6.285E-05
9.000E+03	5.296E-05
9.500E+03	4.504E-05
1.000E+04	3.863E-05
1.050E+04	3.337E-05
1.100E+04	2.903E-05
1.150E+04	2.541E-05
1.200E+04	2.237E-05
1.250E+04	1.979E-05

1.300E+04	1.760E-05
1.350E+04	1.571E-05
1.400E+04	1.409E-05
1.450E+04	1.268E-05
1.500E+04	1.146E-05

freq	v(4)	1.000E-06	1.000E-04	1.000E-02	1.000E+00
5.000E+02	1.935E-01	.	.	.	*
1.000E+03	3.275E-02	.	.	.	*
1.500E+03	1.057E-02	.	.	*	.
2.000E+03	4.614E-03	.	.	*	.
2.500E+03	2.402E-03	.	.	*	.
3.000E+03	1.403E-03	.	.	*	.
3.500E+03	8.884E-04	.	.	*	.
4.000E+03	5.973E-04	.	.	*	.
4.500E+03	4.206E-04	.	.	*	.
5.000E+03	3.072E-04	.	.	*	.
5.500E+03	2.311E-04	.	.	*	.
6.000E+03	1.782E-04	.	.	*	.
6.500E+03	1.403E-04	.	.	*	.
7.000E+03	1.124E-04	.	.	*	.
7.500E+03	9.141E-05	.	.	*	.
8.000E+03	7.536E-05	.	.	*	.
8.500E+03	6.285E-05	.	.	*	.
9.000E+03	5.296E-05	.	.	*	.
9.500E+03	4.504E-05	.	.	*	.
1.000E+04	3.863E-05	.	.	*	.
1.050E+04	3.337E-05	.	.	*	.
1.100E+04	2.903E-05	.	.	*	.
1.150E+04	2.541E-05	.	.	*	.
1.200E+04	2.237E-05	.	.	*	.
1.250E+04	1.979E-05	.	.	*	.
1.300E+04	1.760E-05	.	.	*	.
1.350E+04	1.571E-05	.	.	*	.
1.400E+04	1.409E-05	.	.	*	.
1.450E+04	1.268E-05	.	.	*	.
1.500E+04	1.146E-05	.	.	*	.

7.8.7 Multiple-source AC network

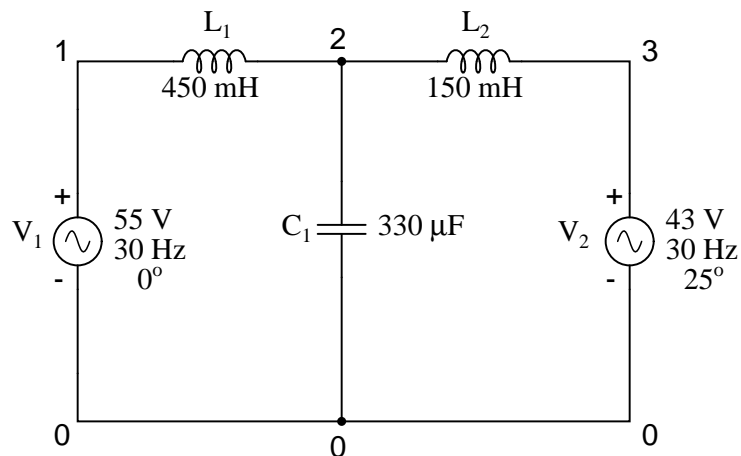

One of the idiosyncrasies of SPICE is its inability to handle any loop in a circuit exclusively composed of series voltage sources and inductors. Therefore, the "loop" of V_1 - L_1 - L_2 - V_2 - V_1 is unacceptable. To get around this, I had to insert a *low*-resistance resistor somewhere in that loop to break it up. Thus, we have R_{bogus} between 3 and 4 (with 1 pico-ohm of resistance), and V_2 between 4 and 0. The circuit above is the original design, while the circuit below has R_{bogus} inserted to avoid the SPICE error.

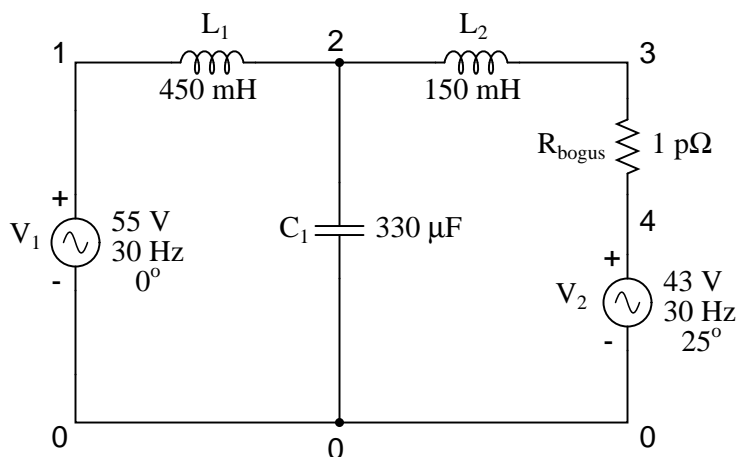
**Netlist:**

```
Multiple ac source
v1 1 0 ac 55 0 sin
v2 4 0 ac 43 25 sin
l1 1 2 450m
c1 2 0 330u
l2 2 3 150m
```

```
rbogus 3 4 1e-12
.ac lin 1 30 30
.print ac v(2)
.end
```

Output:

```
freq          v(2)
3.000E+01     1.413E+02
```

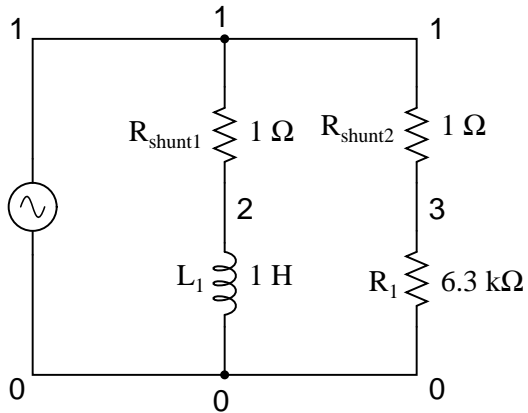
7.8.8 AC phase shift demonstration

The currents through each leg are indicated by the voltage drops across each respective shunt resistor (1 amp = 1 volt through 1 Ω), output by the `v(1,2)` and `v(1,3)` terms of the `.print` card. The phase of the currents through each leg are indicated by the phase of the voltage drops across each respective shunt resistor, output by the `vp(1,2)` and `vp(1,3)` terms in the `.print` card.

Netlist:

```
phase shift
v1 1 0 ac 4 sin
rshunt1 1 2 1
rshunt2 1 3 1
l1 2 0 1
r1 3 0 6.3k
.ac lin 1 1000 1000
.print ac v(1,2) v(1,3) vp(1,2) vp(1,3)
.end
```

Output:

```
freq          v(1,2)          v(1,3)          vp(1,2)          vp(1,3)
1.000E+03     6.366E-04     6.349E-04     -9.000E+01     0.000E+00
```

7.8.9 Transformer circuit

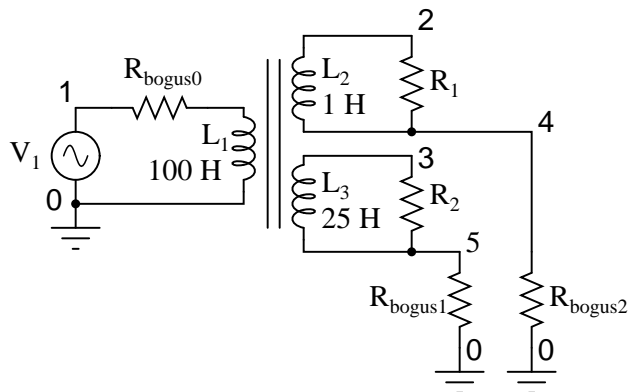

SPICE understands transformers as a set of mutually coupled inductors. Thus, to simulate a transformer in SPICE, you must specify the primary and secondary windings as separate inductors, then instruct SPICE to link them together with a "k" card specifying the coupling constant. For ideal transformer simulation, the coupling constant would be unity (1). However, SPICE can't handle this value, so we use something like 0.999 as the coupling factor.

Note that *all* winding inductor pairs must be coupled with their own k cards in order for the simulation to work properly. For a two-winding transformer, a single k card will suffice. For a three-winding transformer, three k cards must be specified (to link L_1 with L_2 , L_2 with L_3 , and L_1 with L_3).

The L_1/L_2 inductance ratio of 100:1 provides a 10:1 step-down voltage transformation ratio. With 120 volts in we should see 12 volts out of the L_2 winding. The L_1/L_3 inductance ratio of 100:25 (4:1) provides a 2:1 step-down voltage transformation ratio, which should give us 60 volts out of the L_3 winding with 120 volts in.

Netlist:

```
transformer
v1 1 0 ac 120 sin
rbogus0 1 6 1e-3
l1 6 0 100
l2 2 4 1
l3 3 5 25
k1 11 12 0.999
k2 12 13 0.999
k3 11 13 0.999
r1 2 4 1000
r2 3 5 1000
rbogus1 5 0 1e10
rbogus2 4 0 1e10
.ac lin 1 60 60
.print ac v(1,0) v(2,0) v(3,0)
.end
```

Output:

```
freq          v(1)          v(2)          v(3)
6.000E+01    1.200E+02    1.199E+01    5.993E+01
```

In this example, R_{bogus0} is a very low-value resistor, serving to break up the source/inductor loop of V_1/L_1 . R_{bogus1} and R_{bogus2} are very high-value resistors necessary to provide DC paths to ground on each of the isolated circuits. Note as well that one side of the primary circuit is directly grounded. Without these ground references, SPICE will produce errors!

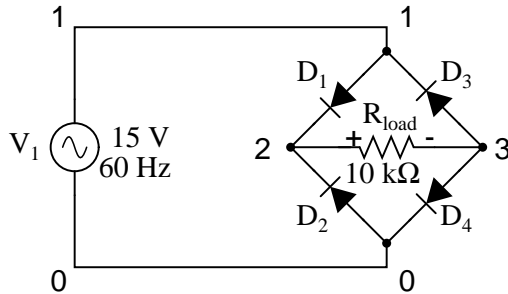
7.8.10 Full-wave bridge rectifier

Diodes, like all semiconductor components in SPICE, must be modeled so that SPICE knows all the nitty-gritty details of how they're supposed to work. Fortunately, SPICE comes with a few generic models, and the diode is the most basic. Notice the `.model` card which simply specifies "d" as the generic diode model for `mod1`. Again, since we're plotting the waveforms here, we need to specify all parameters of the AC source in a single card and print/plot all values using the `.tran` option.

Netlist:

```
fullwave bridge rectifier
v1 1 0 sin(0 15 60 0 0)
rload 1 0 10k
d1 1 2 mod1
d2 0 2 mod1
d3 3 1 mod1
d4 3 0 mod1
.model mod1 d
.tran .5m 25m
.plot tran v(1,0) v(2,3)
.end
```

Output:

```
legend:
*: v(1)
+: v(2,3)
time          v(1)
(*)----- -2.000E+01  -1.000E+01   0.000E+00   1.000E+01   2.000E+01
```



```

(+)----- -5.000E+00  0.000E+00  5.000E+00  1.000E+01  1.500E+01
-----
0.000E+00  0.000E+00 .      +      *      .      .
5.000E-04  2.806E+00 .      .      +      .      *      .      .
1.000E-03  5.483E+00 .      .      .      +      *      .      .
1.500E-03  7.929E+00 .      .      .      .      +      *      .      .
2.000E-03  1.013E+01 .      .      .      .      .      +**     .      .
2.500E-03  1.198E+01 .      .      .      .      .      .      * +     .      .
3.000E-03  1.338E+01 .      .      .      .      .      .      * +     .      .
3.500E-03  1.435E+01 .      .      .      .      .      .      * +     .      .
4.000E-03  1.476E+01 .      .      .      .      .      .      * +     .      .
4.500E-03  1.470E+01 .      .      .      .      .      .      * +     .      .
5.000E-03  1.406E+01 .      .      .      .      .      .      * +     .      .
5.500E-03  1.299E+01 .      .      .      .      .      .      * +     .      .
6.000E-03  1.139E+01 .      .      .      .      .      .      **+     .      .
6.500E-03  9.455E+00 .      .      .      .      .      + *     .      .
7.000E-03  7.113E+00 .      .      .      +      *     .      .      .
7.500E-03  4.591E+00 .      .      .      +      *     .      .      .
8.000E-03  1.841E+00 .      .      +      .      *     .      .      .
8.500E-03  -9.177E-01 .      .      +      *     .      .      .      .
9.000E-03  -3.689E+00 .      .      .      **+     .      .      .      .
9.500E-03  -6.380E+00 .      .      *     .      +     .      .      .      .
1.000E-02  -8.784E+00 .      .      *     .      .      +     .      .      .      .
1.050E-02  -1.075E+01 .      *     .      .      .      .      +     .      .      .
1.100E-02  -1.255E+01 .      *     .      .      .      .      .      +     .      .
1.150E-02  -1.372E+01 .      *     .      .      .      .      .      .      +     .      .
1.200E-02  -1.460E+01 .      *     .      .      .      .      .      .      .      +     .      .
1.250E-02  -1.476E+01 .      *     .      .      .      .      .      .      .      .      +     .      .
1.300E-02  -1.460E+01 .      *     .      .      .      .      .      .      .      .      +     .      .
1.350E-02  -1.373E+01 .      *     .      .      .      .      .      .      .      .      +     .      .
1.400E-02  -1.254E+01 .      *     .      .      .      .      .      .      .      .      +     .      .
1.450E-02  -1.077E+01 .      *     .      .      .      .      .      .      +     .      .      .
1.500E-02  -8.726E+00 .      .      *     .      .      .      +     .      .      .      .
1.550E-02  -6.293E+00 .      .      *     .      .      +     .      .      .      .      .
1.600E-02  -3.684E+00 .      .      .      .      X     .      .      .      .      .      .
1.650E-02  -9.361E-01 .      .      .      +      *     .      .      .      .      .      .
1.700E-02  1.875E+00 .      .      .      +      .      *     .      .      .      .      .
1.750E-02  4.552E+00 .      .      .      .      +      *     .      .      .      .      .
1.800E-02  7.170E+00 .      .      .      .      .      +      *     .      .      .      .
1.850E-02  9.401E+00 .      .      .      .      .      .      + *     .      .      .      .
1.900E-02  1.146E+01 .      .      .      .      .      .      .      **+     .      .      .
1.950E-02  1.293E+01 .      .      .      .      .      .      .      * +     .      .      .
2.000E-02  1.414E+01 .      .      .      .      .      .      .      * +     .      .      .
2.050E-02  1.464E+01 .      .      .      .      .      .      .      * +     .      .      .
2.100E-02  1.483E+01 .      .      .      .      .      .      .      * +     .      .      .
2.150E-02  1.430E+01 .      .      .      .      .      .      .      * +     .      .      .

```

```

2.200E-02  1.344E+01  .      .      .      .      *  +  .
2.250E-02  1.195E+01  .      .      .      .      **  .
2.300E-02  1.016E+01  .      .      .      .      ++  .
2.350E-02  7.917E+00  .      .      .      +  *  .
2.400E-02  5.460E+00  .      .      +  *  .
2.450E-02  2.809E+00  .      +  .  *  .
2.500E-02 -8.297E-04  .      +  .  *  .
-----

```

7.8.11 Common-base BJT transistor amplifier

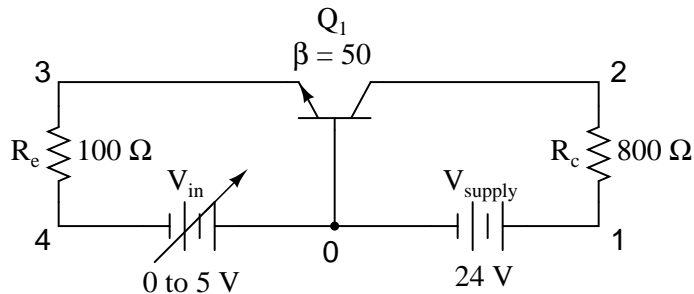

This analysis sweeps the input voltage (V_{in}) from 0 to 5 volts in 0.1 volt increments, then prints out the voltage between the collector and emitter leads of the transistor $v(2,3)$. The transistor ($Q1$) is an NPN with a forward Beta of 50.

Netlist:

```

Common-base BJT amplifier
vsupply 1 0 dc 24
vin 0 4 dc
rc 1 2 800
re 3 4 100
q1 2 0 3 mod1
.model mod1 npn bf=50
.dc vin 0 5 0.1
.print dc v(2,3)
.plot dc v(2,3)
.end

```

Output:

```

vin      v(2,3)
0.000E+00  2.400E+01
1.000E-01  2.410E+01
2.000E-01  2.420E+01
3.000E-01  2.430E+01
4.000E-01  2.440E+01
5.000E-01  2.450E+01

```

6.000E-01	2.460E+01
7.000E-01	2.466E+01
8.000E-01	2.439E+01
9.000E-01	2.383E+01
1.000E+00	2.317E+01
1.100E+00	2.246E+01
1.200E+00	2.174E+01
1.300E+00	2.101E+01
1.400E+00	2.026E+01
1.500E+00	1.951E+01
1.600E+00	1.876E+01
1.700E+00	1.800E+01
1.800E+00	1.724E+01
1.900E+00	1.648E+01
2.000E+00	1.572E+01
2.100E+00	1.495E+01
2.200E+00	1.418E+01
2.300E+00	1.342E+01
2.400E+00	1.265E+01
2.500E+00	1.188E+01
2.600E+00	1.110E+01
2.700E+00	1.033E+01
2.800E+00	9.560E+00
2.900E+00	8.787E+00
3.000E+00	8.014E+00
3.100E+00	7.240E+00
3.200E+00	6.465E+00
3.300E+00	5.691E+00
3.400E+00	4.915E+00
3.500E+00	4.140E+00
3.600E+00	3.364E+00
3.700E+00	2.588E+00
3.800E+00	1.811E+00
3.900E+00	1.034E+00
4.000E+00	2.587E-01
4.100E+00	9.744E-02
4.200E+00	7.815E-02
4.300E+00	6.806E-02
4.400E+00	6.141E-02
4.500E+00	5.657E-02
4.600E+00	5.281E-02
4.700E+00	4.981E-02
4.800E+00	4.734E-02
4.900E+00	4.525E-02
5.000E+00	4.346E-02

vin	v(2,3)	0.000E+00	1.000E+01	2.000E+01	3.000E+01
0.000E+00	2.400E+01	.	.	.	*
1.000E-01	2.410E+01	.	.	.	*
2.000E-01	2.420E+01	.	.	.	*
3.000E-01	2.430E+01	.	.	.	*
4.000E-01	2.440E+01	.	.	.	*
5.000E-01	2.450E+01	.	.	.	*
6.000E-01	2.460E+01	.	.	.	*
7.000E-01	2.466E+01	.	.	.	*
8.000E-01	2.439E+01	.	.	.	*
9.000E-01	2.383E+01	.	.	.	*
1.000E+00	2.317E+01	.	.	.	*
1.100E+00	2.246E+01	.	.	.	*
1.200E+00	2.174E+01	.	.	.	*
1.300E+00	2.101E+01	.	.	.	*
1.400E+00	2.026E+01	.	.	.	*
1.500E+00	1.951E+01	.	.	.	*
1.600E+00	1.876E+01	.	.	.	*
1.700E+00	1.800E+01	.	.	.	*
1.800E+00	1.724E+01	.	.	.	*
1.900E+00	1.648E+01	.	.	.	*
2.000E+00	1.572E+01	.	.	.	*
2.100E+00	1.495E+01	.	.	.	*
2.200E+00	1.418E+01	.	.	.	*
2.300E+00	1.342E+01	.	.	.	*
2.400E+00	1.265E+01	.	.	.	*
2.500E+00	1.188E+01	.	.	.	*
2.600E+00	1.110E+01	.	.	.	*
2.700E+00	1.033E+01	.	.	.	*
2.800E+00	9.560E+00	.	.	.	*
2.900E+00	8.787E+00	.	.	.	*
3.000E+00	8.014E+00	.	.	.	*
3.100E+00	7.240E+00	.	.	.	*
3.200E+00	6.465E+00	.	.	.	*
3.300E+00	5.691E+00	.	.	.	*
3.400E+00	4.915E+00	.	.	.	*
3.500E+00	4.140E+00	.	.	.	*
3.600E+00	3.364E+00	.	.	.	*
3.700E+00	2.588E+00	.	.	.	*
3.800E+00	1.811E+00	.	.	.	*
3.900E+00	1.034E+00	.	.	.	*
4.000E+00	2.587E-01	.	.	.	*
4.100E+00	9.744E-02	.	.	.	*
4.200E+00	7.815E-02	.	.	.	*
4.300E+00	6.806E-02	.	.	.	*

```

4.400E+00  6.141E-02 *
4.500E+00  5.657E-02 *
4.600E+00  5.281E-02 *
4.700E+00  4.981E-02 *
4.800E+00  4.734E-02 *
4.900E+00  4.525E-02 *
5.000E+00  4.346E-02 *

```

7.8.12 Common-source JFET amplifier with self-bias

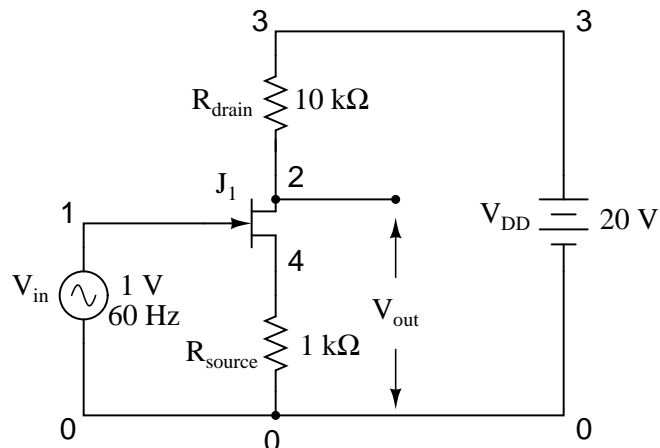

Netlist:

```

common source jfet amplifier
vin 1 0 sin(0 1 60 0 0)
vdd 3 0 dc 20
rdrain 3 2 10k
rsource 4 0 1k
j1 2 1 4 mod1
.model mod1 njf
.tran 1m 30m
.plot tran v(2,0) v(1,0)
.end

```

Output:

```

legend:
*: v(2)
+: v(1)
time      v(2)
(*)----- 1.400E+01   1.600E+01   1.800E+01   2.000E+01   2.200E+01
(+)----- -1.000E+00   -5.000E-01   0.000E+00   5.000E-01   1.000E+00

```

0.000E+00	1.708E+01	.	.	*	+	.	.
1.000E-03	1.609E+01	.	.*	.	.	+	.
2.000E-03	1.516E+01	.	*	.	.	.	+
3.000E-03	1.448E+01	.	*	.	.	.	+
4.000E-03	1.419E+01	.*	+
5.000E-03	1.432E+01	.	*	.	.	.	+
6.000E-03	1.490E+01	.	*	.	.	.	+
7.000E-03	1.577E+01	.	*	.	.	+	.
8.000E-03	1.676E+01	.	.	*	.	+	.
9.000E-03	1.768E+01	.	.	.	+	*	.
1.000E-02	1.841E+01	*	.
1.100E-02	1.890E+01	.	+	.	.	*	.
1.200E-02	1.912E+01	.*	.	.	.	*	.
1.300E-02	1.912E+01	.*	.	.	.	*	.
1.400E-02	1.890E+01	.	+	.	.	*	.
1.500E-02	1.842E+01	*	.
1.600E-02	1.768E+01	.	.	.	+	*	.
1.700E-02	1.676E+01	.	.	*	.	.	+
1.800E-02	1.577E+01	.	*	.	.	.	+
1.900E-02	1.491E+01	.	*	.	.	.	+
2.000E-02	1.432E+01	.*	+
2.100E-02	1.419E+01	.*	+
2.200E-02	1.449E+01	.	*	.	.	.	+
2.300E-02	1.516E+01	.	*	.	.	.	+
2.400E-02	1.609E+01	.	.	.*	.	.	+
2.500E-02	1.708E+01	.	.	.	*	.	+
2.600E-02	1.796E+01	+	*
2.700E-02	1.861E+01	*	.
2.800E-02	1.900E+01	.	+	.	.	.	*
2.900E-02	1.916E+01	+	*
3.000E-02	1.908E+01	.*	*

7.8.13 Inverting op-amp circuit

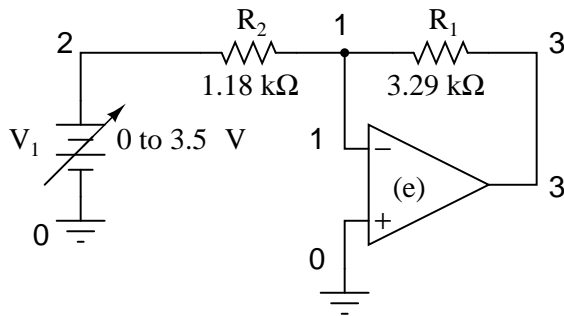

To simulate an ideal operational amplifier in SPICE, we use a voltage-dependent voltage source as a differential amplifier with extremely high gain. The "e" card sets up the dependent voltage source with four nodes, 3 and 0 for voltage output, and 1 and 0 for voltage input. No power supply is needed for the dependent voltage source, unlike a real operational amplifier. The voltage gain is set at 999,000 in this case. The input voltage source (V_1) sweeps from 0 to 3.5 volts in 0.05 volt steps.

Netlist:

```
Inverting opamp
v1 2 0 dc
e 3 0 0 1 999k
r1 3 1 3.29k
r2 1 2 1.18k
.dc v1 0 3.5 0.05
.print dc v(3,0)
.end
```

Output:

v1	v(3)
0.000E+00	0.000E+00
5.000E-02	-1.394E-01
1.000E-01	-2.788E-01
1.500E-01	-4.182E-01
2.000E-01	-5.576E-01
2.500E-01	-6.970E-01
3.000E-01	-8.364E-01
3.500E-01	-9.758E-01
4.000E-01	-1.115E+00
4.500E-01	-1.255E+00
5.000E-01	-1.394E+00
5.500E-01	-1.533E+00
6.000E-01	-1.673E+00
6.500E-01	-1.812E+00
7.000E-01	-1.952E+00
7.500E-01	-2.091E+00
8.000E-01	-2.231E+00
8.500E-01	-2.370E+00
9.000E-01	-2.509E+00
9.500E-01	-2.649E+00
1.000E+00	-2.788E+00
1.050E+00	-2.928E+00
1.100E+00	-3.067E+00
1.150E+00	-3.206E+00
1.200E+00	-3.346E+00
1.250E+00	-3.485E+00
1.300E+00	-3.625E+00

1.350E+00	-3.764E+00
1.400E+00	-3.903E+00
1.450E+00	-4.043E+00
1.500E+00	-4.182E+00
1.550E+00	-4.322E+00
1.600E+00	-4.461E+00
1.650E+00	-4.600E+00
1.700E+00	-4.740E+00
1.750E+00	-4.879E+00
1.800E+00	-5.019E+00
1.850E+00	-5.158E+00
1.900E+00	-5.297E+00
1.950E+00	-5.437E+00
2.000E+00	-5.576E+00
2.050E+00	-5.716E+00
2.100E+00	-5.855E+00
2.150E+00	-5.994E+00
2.200E+00	-6.134E+00
2.250E+00	-6.273E+00
2.300E+00	-6.413E+00
2.350E+00	-6.552E+00
2.400E+00	-6.692E+00
2.450E+00	-6.831E+00
2.500E+00	-6.970E+00
2.550E+00	-7.110E+00
2.600E+00	-7.249E+00
2.650E+00	-7.389E+00
2.700E+00	-7.528E+00
2.750E+00	-7.667E+00
2.800E+00	-7.807E+00
2.850E+00	-7.946E+00
2.900E+00	-8.086E+00
2.950E+00	-8.225E+00
3.000E+00	-8.364E+00
3.050E+00	-8.504E+00
3.100E+00	-8.643E+00
3.150E+00	-8.783E+00
3.200E+00	-8.922E+00
3.250E+00	-9.061E+00
3.300E+00	-9.201E+00
3.350E+00	-9.340E+00
3.400E+00	-9.480E+00
3.450E+00	-9.619E+00
3.500E+00	-9.758E+00

7.8.14 Noninverting op-amp circuit

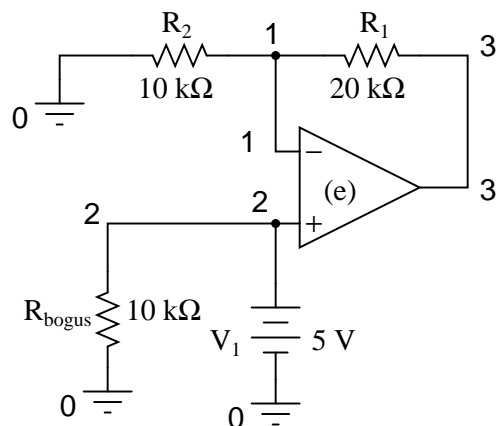

Another example of a SPICE quirk: since the dependent voltage source "e" isn't considered a load to voltage source V_1 , SPICE interprets V_1 to be open-circuited and will refuse to analyze it. The fix is to connect R_{bogus} in parallel with V_1 to act as a DC load. Being directly connected across V_1 , the resistance of R_{bogus} is not crucial to the operation of the circuit, so 10 k Ω will work fine. I decided not to sweep the V_1 input voltage at all in this circuit for the sake of keeping the netlist and output listing simple.

Netlist:

```
noninverting opamp
v1 2 0 dc 5
rbogus 2 0 10k
e 3 0 2 1 999k
r1 3 1 20k
r2 1 0 10k
.end
```

Output:

node	voltage	node	voltage	node	voltage
(1)	5.0000	(2)	5.0000	(3)	15.0000

7.8.15 Instrumentation amplifier

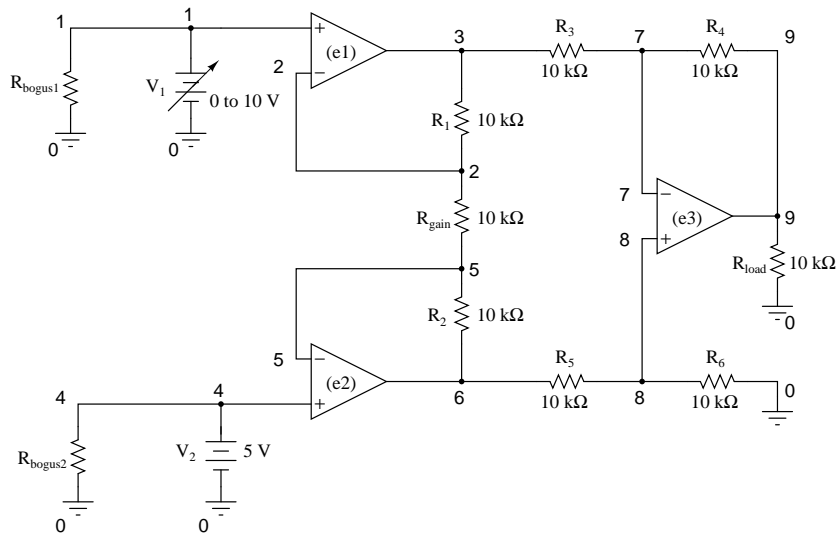

Note the very high-resistance R_{bogus1} and R_{bogus2} resistors in the netlist (not shown in schematic for brevity) across each input voltage source, to keep SPICE from thinking V_1 and V_2 were open-circuited, just like the other op-amp circuit examples.

Netlist:

Instrumentation amplifier

```
v1 1 0
rbogus1 1 0 9e12
v2 4 0 dc 5
rbogus2 4 0 9e12
e1 3 0 1 2 999k
e2 6 0 4 5 999k
e3 9 0 8 7 999k
rload 9 0 10k
r1 2 3 10k
rgain 2 5 10k
r2 5 6 10k
r3 3 7 10k
r4 7 9 10k
r5 6 8 10k
r6 8 0 10k
.dc v1 0 10 1
.print dc v(9) v(3,6)
.end
```

Output:

```
v1          v(9)          v(3,6)
```

```

0.000E+00    1.500E+01   -1.500E+01
1.000E+00    1.200E+01   -1.200E+01
2.000E+00    9.000E+00   -9.000E+00
3.000E+00    6.000E+00   -6.000E+00
4.000E+00    3.000E+00   -3.000E+00
5.000E+00    9.955E-11   -9.956E-11
6.000E+00   -3.000E+00    3.000E+00
7.000E+00   -6.000E+00    6.000E+00
8.000E+00   -9.000E+00    9.000E+00
9.000E+00   -1.200E+01    1.200E+01
1.000E+01   -1.500E+01    1.500E+01

```

7.8.16 Op-amp integrator with sinewave input

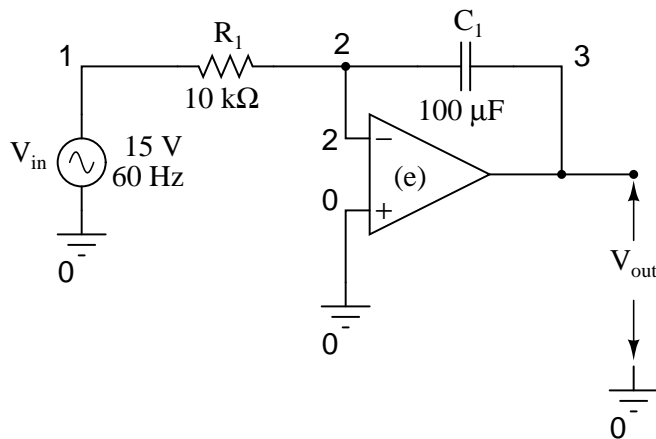

Netlist:

```

Integrator with sinewave input
vin 1 0 sin (0 15 60 0 0)
r1 1 2 10k
c1 2 3 150u ic=0
e 3 0 0 2 999k
.tran 1m 30m uic
.plot tran v(1,0) v(3,0)
.end

```

Output:

```

legend:
*: v(1)
+: v(3)
time      v(1)
(*)----- -2.000E+01   -1.000E+01    0.000E+00    1.000E+01

```

```

(+)------ -6.000E-02   -4.000E-02   -2.000E-02   0.000E+00
-----
0.000E+00  6.536E-08 .           .           *           +           .
1.000E-03  5.516E+00 .           .           .           *           +           .
2.000E-03  1.021E+01 .           .           .           +           *           .
3.000E-03  1.350E+01 .           .           .           +           .           *           .
4.000E-03  1.495E+01 .           .           +           .           .           *           .
5.000E-03  1.418E+01 .           .           +           .           .           *           .
6.000E-03  1.150E+01 .           +           .           .           .           *           .
7.000E-03  7.214E+00 . +           .           .           .           *           .           .
8.000E-03  1.867E+00 .+           .           .           *           .           .           .
9.000E-03  -3.709E+00 . +           .           *           .           .           .           .
1.000E-02  -8.805E+00 . +           .           *           .           .           .           .
1.100E-02  -1.259E+01 . *           +           .           .           .           .           .
1.200E-02  -1.466E+01 . *           .           +           .           .           .           .
1.300E-02  -1.471E+01 . *           .           .           +           .           .           .
1.400E-02  -1.259E+01 . *           .           .           .           +           .           .
1.500E-02  -8.774E+00 . .           *           .           .           +           .           .
1.600E-02  -3.723E+00 . .           .           *           .           .           +           .           .
1.700E-02  1.870E+00 . .           .           .           *           .           +           .           .
1.800E-02  7.188E+00 . .           .           .           .           *           +           .           .
1.900E-02  1.154E+01 . .           .           .           .           +           .           *           .
2.000E-02  1.418E+01 . .           .           .           +           .           .           *           .
2.100E-02  1.490E+01 . .           .           +           .           .           .           *           .
2.200E-02  1.355E+01 . .           .           +           .           .           .           *           .
2.300E-02  1.020E+01 . .           +           .           .           .           *           .           .
2.400E-02  5.496E+00 . +           .           .           .           *           .           .           .
2.500E-02  -1.486E-03 .+           .           .           *           .           .           .           .
2.600E-02  -5.489E+00 . +           .           *           .           .           .           .           .
2.700E-02  -1.021E+01 . .           +           *           .           .           .           .           .
2.800E-02  -1.355E+01 . *           .           +           .           .           .           .           .
2.900E-02  -1.488E+01 . *           .           .           +           .           .           .           .
3.000E-02  -1.427E+01 . *           .           .           .           +           .           .           .
-----

```

7.8.17 Op-amp integrator with squarewave input

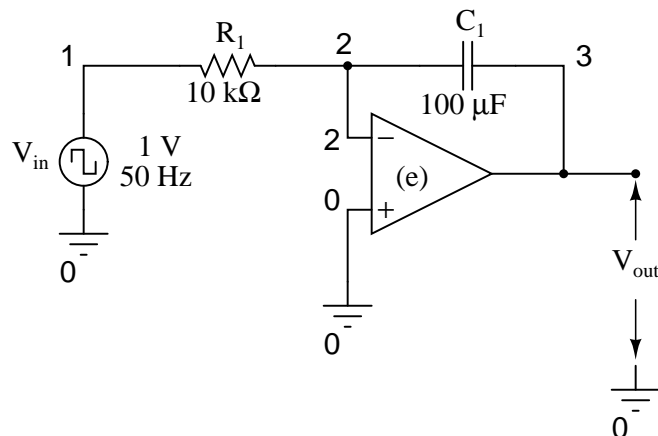
**Netlist:**

```

Integrator with squarewave input
vin 1 0 pulse (-1 1 0 0 0 10m 20m)
r1 1 2 1k
c1 2 3 150u ic=0
e 3 0 0 2 999k
.tran 1m 50m uic
.plot tran v(1,0) v(3,0)
.end

```

Output:

legend:

*: v(1)

+: v(3)

time	v(1)					
(*)-----	-1.000E+00	-5.000E-01	0.000E+00	5.000E-01	1.000E+00	
(+)-----	-1.000E-01	-5.000E-02	0.000E+00	5.000E-02	1.000E-01	

0.000E+00	-1.000E+00	*	.	+	.	.
1.000E-03	1.000E+00	.	.	+	.	*
2.000E-03	1.000E+00	.	.	+	.	*
3.000E-03	1.000E+00	.	.	+	.	*
4.000E-03	1.000E+00	.	.	+	.	*
5.000E-03	1.000E+00	.	.	+	.	*
6.000E-03	1.000E+00	.	.	+	.	*
7.000E-03	1.000E+00	.	.	+	.	*
8.000E-03	1.000E+00	.	.	+	.	*
9.000E-03	1.000E+00	.	.	+	.	*
1.000E-02	1.000E+00	.	.	+	.	*

```

1.100E-02  1.000E+00  .   +   .   .   .   .   .   .   *
1.200E-02 -1.000E+00 *   +   .   .   .   .   .   .   .
1.300E-02 -1.000E+00 *       +   .   .   .   .   .   .   .
1.400E-02 -1.000E+00 *           +.   .   .   .   .   .   .
1.500E-02 -1.000E+00 *               .+   .   .   .   .   .   .
1.600E-02 -1.000E+00 *                   . +   .   .   .   .   .   .
1.700E-02 -1.000E+00 *                       .  +   .   .   .   .   .
1.800E-02 -1.000E+00 *                           .   +   .   .   .   .   .
1.900E-02 -1.000E+00 *                               .     +   .   .   .   .
2.000E-02 -1.000E+00 *                                   .       +   .   .   .
2.100E-02  1.000E+00 .                                       .   +   .   .   .   .   *
2.200E-02  1.000E+00 .                                           .     +   .   .   .   .   *
2.300E-02  1.000E+00 .                                               .       +   .   .   .   .   *
2.400E-02  1.000E+00 .                                                   .   +   .   .   .   .   *
2.500E-02  1.000E+00 .                                                       .     +   .   .   .   .   *
2.600E-02  1.000E+00 .                                                           .       +   .   .   .   .   *
2.700E-02  1.000E+00 .                                                               .   +   .   .   .   .   *
2.800E-02  1.000E+00 .                                                                   .     +   .   .   .   .   *
2.900E-02  1.000E+00 .                                                                       .       +   .   .   .   .   *
3.000E-02  1.000E+00 .                                                                           .   +   .   .   .   .   *
3.100E-02  1.000E+00 .                                                                               .     +   .   .   .   .   *
3.200E-02 -1.000E+00 * +   .   .   .   .   .   .   .   .   .   .
3.300E-02 -1.000E+00 * +   .   .   .   .   .   .   .   .   .   .
3.400E-02 -1.000E+00 * +   .   .   .   .   .   .   .   .   .   .
3.500E-02 -1.000E+00 * +   .   .   .   .   .   .   .   .   .   .
3.600E-02 -1.000E+00 * +   .   .   .   .   .   .   .   .   .   .
3.700E-02 -1.000E+00 * +   .   .   .   .   .   .   .   .   .   .
3.800E-02 -1.000E+00 * +   .   .   .   .   .   .   .   .   .   .
3.900E-02 -1.000E+00 * +   .   .   .   .   .   .   .   .   .   .
4.000E-02 -1.000E+00 * +   .   .   .   .   .   .   .   .   .   .
4.100E-02  1.000E+00 .   .   .   .   .   .   .   .   .   .   *
4.200E-02  1.000E+00 .   .   .   .   .   .   .   .   .   .   *
4.300E-02  1.000E+00 .   .   .   .   .   .   .   .   .   .   *
4.400E-02  1.000E+00 .   .   .   .   .   .   .   .   .   .   *
4.500E-02  1.000E+00 .   .   .   .   .   .   .   .   .   .   *
4.600E-02  1.000E+00 .   .   .   .   .   .   .   .   .   .   *
4.700E-02  1.000E+00 .   .   .   .   .   .   .   .   .   .   *
4.800E-02  1.000E+00 .   .   .   .   .   .   .   .   .   .   *
4.900E-02  1.000E+00 .   .   .   .   .   .   .   .   .   .   *
5.000E-02  1.000E+00 +   .   .   .   .   .   .   .   .   .   *
-----

```

Chapter 8

TROUBLESHOOTING – THEORY AND PRACTICE

8.1

Perhaps the most valuable but difficult-to-learn skill any technical person could have is the ability to troubleshoot a system. For those unfamiliar with the term, *troubleshooting* means the act of pinpointing and correcting problems in any kind of system. For an auto mechanic, this means determining and fixing problems in cars based on the car's behavior. For a doctor, this means correctly diagnosing a patient's malady and prescribing a cure. For a business expert, this means identifying the source(s) of inefficiency in a corporation and recommending corrective measures.

Troubleshooters must be able to determine the cause or causes of a problem simply by examining its effects. Rarely does the source of a problem directly present itself for all to see. Cause/effect relationships are often complex, even for seemingly simple systems, and often the proficient troubleshooter is regarded by others as something of a miracle-worker for their ability to quickly discern the root cause of a problem. While some people are gifted with a natural talent for troubleshooting, it is a skill that can be learned like any other.

Sometimes the system to be analyzed is in so bad a state of affairs that there is no hope of ever getting it working again. When investigators sift through the wreckage of a crashed airplane, or when a doctor performs an autopsy, they must do their best to determine the cause of massive failure after the fact. Fortunately, the task of the troubleshooter is usually not this grim. Typically, a misbehaving system is still functioning to some degree and may be stimulated and adjusted by the troubleshooter as part of the diagnostic procedure. In this sense, troubleshooting is a lot like scientific method: determining cause/effect relationships by means of live experimentation.

Like science, troubleshooting is a mixture of standard procedure and personal creativity. There are certain procedures employed as tools to discern cause(s) from effects, but they are impotent if not coupled with a creative and inquisitive mind. In the course of troubleshooting, the troubleshooter may have to invent their own specific technique – adapted to the particular system they're working on – and/or modify tools to perform a special task. Creativity is necessary in examining a problem from different perspectives: learning to ask different questions when the "standard" questions don't lead to fruitful answers.

If there is one personality trait I've seen positively associated with excellent troubleshooting more than any other, it's technical curiosity. People fascinated by learning how things work, and who aren't discouraged by a challenging problem, tend to be better at troubleshooting than others. Richard Feynman, the late physicist who taught at Caltech for many years, illustrates to me the ultimate troubleshooting personality. Reading any of his (auto)biographical books is both educating and entertaining, and I recommend them to anyone seeking to develop their own scientific reasoning/troubleshooting skills.

8.2 Questions to ask before proceeding

- Has the system ever worked before? If yes, has anything happened to it since then that could cause the problem?
- Has this system proven itself to be prone to certain types of failure?
- How urgent is the need for repair?
- What are the *safety concerns*, before I start troubleshooting?
- What are the process quality concerns, before I start troubleshooting (what can I do without causing interruptions in production)?

These preliminary questions are not trivial. Indeed, they are essential to expedient and safe troubleshooting. They are especially important when the system to be trouble-shot is large, dangerous, and/or expensive.

Sometimes the troubleshooter will be required to work on a system that is still in full operation (perhaps the ultimate example of this is a doctor diagnosing a live patient). Once the cause or causes are determined to a high degree of certainty, there is the step of corrective action. Correcting a system fault without significantly interrupting the operation of the system can be very challenging, and it deserves thorough planning.

When there is high risk involved in taking corrective action, such as is the case with performing surgery on a patient or making repairs to an operating process in a chemical plant, it is essential for the worker(s) to plan ahead for possible trouble. One question to ask before proceeding with repairs is, "how and at what point(s) can I abort the repairs if something goes wrong?" In risky situations, it is vital to have planned "escape routes" in your corrective action, just in case things do not go as planned. A surgeon operating on a patient knows if there are any "points of no return" in such a procedure, and stops to re-check the patient before proceeding past those points. He or she also knows how to "back out" of a surgical procedure at those points if needed.

8.3 General troubleshooting tips

When first approaching a failed or otherwise misbehaving system, the new troubleshooter often doesn't know where to begin. The following strategies are not exhaustive by any means, but provide the troubleshooter with a simple checklist of questions to ask in order to start isolating the problem.

As tips, these troubleshooting suggestions are not comprehensive procedures: they serve as starting points only for the troubleshooting process. An essential part of expedient troubleshooting

is probability assessment, and these tips help the troubleshooter determine which possible points of failure are more or less likely than others. Final isolation of the system failure is usually determined through more specific techniques (outlined in the next section – *Specific Troubleshooting Techniques*).

8.3.1 Prior occurrence

If this device or process has been historically known to fail in a certain particular way, and the conditions leading to this common failure have not changed, check for this "way" first. A corollary to this troubleshooting tip is the directive to keep detailed records of failure. Ideally, a computer-based failure log is optimal, so that failures may be referenced by and correlated to a number of factors such as time, date, and environmental conditions.

Example: *The car's engine is overheating. The last two times this happened, the cause was low coolant level in the radiator.*

What to do: Check the coolant level first. Of course, past history by no means guarantees the present symptoms are caused by the same problem, but since this is more likely, it makes sense to check this first.

If, however, the cause of routine failure in a system has been corrected (i.e. the leak causing low coolant level in the past has been repaired), then this may not be a probable cause of trouble this time.

8.3.2 Recent alterations

If a system has been having problems immediately after some kind of maintenance or other change, the problems might be linked to those changes.

Example: *The mechanic recently tuned my car's engine, and now I hear a rattling noise that I didn't hear before I took the car in for repair.*

What to do: Check for something that may have been left loose by the mechanic after his or her tune-up work.

8.3.3 Function vs. non-function

If a system isn't producing the desired end result, look for what it *is* doing correctly; in other words, identify where the problem is *not*, and focus your efforts elsewhere. Whatever components or subsystems necessary for the properly working parts to function are probably okay. The degree of fault can often tell you what part of it is to blame.

Example: *The radio works fine on the AM band, but not on the FM band.*

What to do: Eliminate from the list of possible causes, anything in the radio necessary for the AM band's function. Whatever the source of the problem is, it is specific to the FM band and not to the AM band. This eliminates the audio amplifier, speakers, fuse, power supply, and almost all external wiring. Being able to eliminate sections of the system as possible failures reduces the scope of the problem and makes the rest of the troubleshooting procedure more efficient.

8.3.4 Hypothesize

Based on your knowledge of how a system works, think of various kinds of failures that would cause this problem (or these phenomena) to occur, and check for those failures (starting with the most likely based on circumstances, history, or knowledge of component weaknesses).

Example: *The car's engine is overheating.*

What to do: Consider possible causes for overheating, based on what you know of engine operation. Either the engine is generating too much heat, or not getting rid of the heat well enough (most likely the latter). Brainstorm some possible causes: a loose fan belt, clogged radiator, bad water pump, low coolant level, etc. Investigate each one of those possibilities before investigating alternatives.

8.4 Specific troubleshooting techniques

After applying some of the general troubleshooting tips to narrow the scope of a problem's location, there are techniques useful in further isolating it. Here are a few:

8.4.1 Swap identical components

In a system with identical or parallel subsystems, swap components between those subsystems and see whether or not the problem moves with the swapped component. If it does, you've just swapped the faulty component; if it doesn't, keep searching!

This is a powerful troubleshooting method, because it gives you both a positive and a negative indication of the swapped component's fault: when the bad part is exchanged between identical systems, the formerly broken subsystem will start working again and the formerly good subsystem will fail.

I was once able to troubleshoot an elusive problem with an automotive engine ignition system using this method: I happened to have a friend with an automobile sharing the exact same model of ignition system. We swapped parts between the engines (distributor, spark plug wires, ignition coil – one at a time) until the problem moved to the other vehicle. The problem happened to be a "weak" ignition coil, and it only manifested itself under heavy load (a condition that could not be simulated in my garage). Normally, this type of problem could only be pinpointed using an ignition system analyzer (or oscilloscope) *and* a dynamometer to simulate loaded driving conditions. This technique, however, confirmed the source of the problem with 100% accuracy, using no diagnostic equipment whatsoever.

Occasionally you may swap a component and find that the problem still exists, but has changed in some way. This tells you that the components you just swapped are *somehow different* (different calibration, different function), and nothing more. However, don't dismiss this information just because it doesn't lead you straight to the problem – look for other changes in the system as a whole as a result of the swap, and try to figure out what these changes tell you about the source of the problem.

An important caveat to this technique is the possibility of causing further damage. Suppose a component has failed because of another, less conspicuous failure in the system. Swapping the failed component with a good component will cause the good component to fail as well. For example,

suppose that a circuit develops a short, which "blows" the protective fuse for that circuit. The blown fuse is not evident by inspection, and you don't have a meter to electrically test the fuse, so you decide to swap the suspect fuse with one of the same rating from a working circuit. As a result of this, the good fuse that you move to the shorted circuit blows as well, leaving you with two blown fuses and two non-working circuits. At least you know for certain that the original fuse *was* blown, because the circuit it was moved to stopped working after the swap, but this knowledge was gained only through the loss of a good fuse and the additional "down time" of the second circuit.

Another example to illustrate this caveat is the ignition system problem previously mentioned. Suppose that the "weak" ignition coil had caused the engine to backfire, damaging the muffler. If swapping ignition system components with another vehicle causes the problem to move to the other vehicle, damage may be done to the other vehicle's muffler as well. As a general rule, the technique of swapping identical components should be used only when there is minimal chance of causing additional damage. It is an excellent technique for isolating non-destructive problems.

Example 1: *You're working on a CNC machine tool with X, Y, and Z-axis drives. The Y axis is not working, but the X and Z axes are working. All three axes share identical components (feedback encoders, servo motor drives, servo motors).*

What to do: Exchange these identical components, one at a time, Y axis and either one of the working axes (X or Z), and see after each swap whether or not the problem has moved with the swap.

Example 2: *A stereo system produces no sound on the left speaker, but the right speaker works just fine.*

What to do: Try swapping respective components between the two channels and see if the problem changes sides, from left to right. When it does, you've found the defective component. For instance, you could swap the speakers between channels: if the problem moves to the other side (i.e. the same speaker that was dead before is still dead, now that it's connected to the right channel cable) then you know that speaker is bad. If the problem stays on the same side (i.e. the speaker formerly silent is now producing sound after having been moved to the other side of the room and connected to the other cable), then you know the speakers are fine, and the problem must lie somewhere else (perhaps in the cable connecting the silent speaker to the amplifier, or in the amplifier itself).

If the speakers have been verified as good, then you could check the cables using the same method. Swap the cables so that each one now connects to the other channel of the amplifier and to the other speaker. Again, if the problem changes sides (i.e. now the right speaker is now "dead" and the left speaker now produces sound), then the cable now connected to the right speaker must be defective. If neither swap (the speakers nor the cables) causes the problem to change sides from left to right, then the problem must lie within the amplifier (i.e. the left channel output must be "dead").

8.4.2 Remove parallel components

If a system is composed of several parallel or redundant components which can be removed without crippling the whole system, start removing these components (one at a time) and see if things start to work again.

Example 1: A "star" topology communications network between several computers has failed. None of the computers are able to communicate with each other.

What to do: Try unplugging the computers, one at a time from the network, and see if the network starts working again after one of them is unplugged. If it does, then that last unplugged computer may be the one at fault (it may have been "jamming" the network by constantly outputting data or noise).

Example 2: A household fuse keeps blowing (or the breaker keeps tripping open) after a short amount of time.

What to do: Unplug appliances from that circuit until the fuse or breaker quits interrupting the circuit. If you can eliminate the problem by unplugging a single appliance, then that appliance might be defective. If you find that unplugging almost any appliance solves the problem, then the circuit may simply be overloaded by too many appliances, neither of them defective.

8.4.3 Divide system into sections and test those sections

In a system with multiple sections or stages, carefully measure the variables going in and out of each stage until you find a stage where things don't look right.

Example 1: A radio is not working (producing no sound at the speaker)

What to do: Divide the circuitry into stages: tuning stage, mixing stages, amplifier stage, all the way through to the speaker(s). Measure signals at test points between these stages and tell whether or not a stage is working properly.

Example 2: An analog summer circuit is not functioning properly.

Analog summer circuit

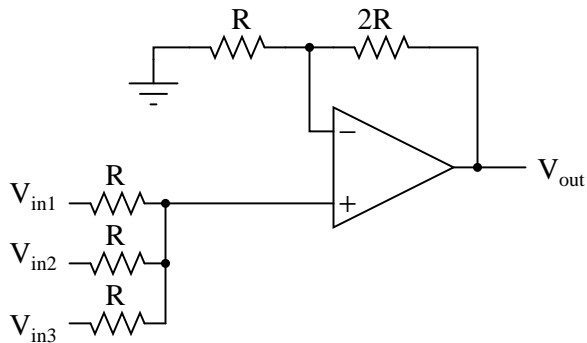

What to do: I would test the passive averager network (the three resistors at the lower-left corner of the schematic) to see that the proper (averaged) voltage was seen at the noninverting input of the op-amp. I would then measure the voltage at the inverting input to see if it was the same as at the noninverting input (or, alternatively, measure the voltage difference between the two inputs of the op-amp, as it should be zero). Continue testing sections of the circuit (or just test points within the circuit) to see if you measure the expected voltages and currents.

8.4.4 Simplify and rebuild

Closely related to the strategy of dividing a system into sections, this is actually a design and fabrication technique useful for new circuits, machines, or systems. It's always easier begin the design and construction process in little steps, leading to larger and larger steps, rather than to build the whole thing at once and try to troubleshoot it as a whole.

Suppose that someone were building a custom automobile. He or she would be foolish to bolt all the parts together without checking and testing components and subsystems as they went along, expecting everything to work perfectly after it's all assembled. Ideally, the builder would check the proper operation of components along the way through the construction process: start and tune the engine *before* it's connected to the drivetrain, check for wiring problems *before* all the cover panels are put in place, check the brake system in the driveway *before* taking it out on the road, etc.

Countless times I've witnessed students build a complex experimental circuit and have trouble getting it to work because they didn't stop to check things along the way: test all resistors *before* plugging them into place, make sure the power supply is regulating voltage adequately *before* trying to power anything with it, etc. It is human nature to rush to completion of a project, thinking that such checks are a waste of valuable time. However, more time will be wasted in troubleshooting a malfunctioning circuit than would be spent checking the operation of subsystems throughout the process of construction.

Take the example of the analog summer circuit in the previous section for example: what if it wasn't working properly? How would you simplify it and test it in stages? Well, you could reconnect the op-amp as a basic comparator and see if it's responsive to differential input voltages, and/or connect it as a voltage follower (buffer) and see if it outputs the same analog voltage as what is input. If it doesn't perform these simple functions, it will never perform its function in the summer circuit! By stripping away the complexity of the summer circuit, paring it down to an (almost) bare op-amp, you can test that component's functionality and then build from there (add resistor feedback and check for voltage amplification, then add input resistors and check for voltage summing), checking for expected results along the way.

8.4.5 Trap a signal

Set up instrumentation (such as a datalogger, chart recorder, or multimeter set on "record" mode) to monitor a signal over a period of time. This is especially helpful when tracking down intermittent problems, which have a way of showing up the moment you've turned your back and walked away.

This may be essential for proving what happens first in a fast-acting system. Many fast systems (especially shutdown "trip" systems) have a "first out" monitoring capability to provide this kind of data.

Example #1: *A turbine control system shuts automatically in response to an abnormal condition. By the time a technician arrives at the scene to survey the turbine's condition, however, everything is in a "down" state and it's impossible to tell what signal or condition was responsible for the initial shutdown, as all operating parameters are now "abnormal."*

What to do: One technician I knew used a videocamera to record the turbine control panel, so he could see what happened (by indications on the gauges) first in an automatic-shutdown event. Simply by looking at the panel after the fact, there was no way to tell *which* signal shut the turbine

down, but the videotape playback would show what happened in sequence, down to a frame-by-frame time resolution.

Example #2: *An alarm system is falsely triggering, and you suspect it may be due to a specific wire connection going bad. Unfortunately, the problem never manifests itself while you're watching it!*

What to do: Many modern digital multimeters are equipped with "record" settings, whereby they can monitor a voltage, current, or resistance over time and note whether that measurement deviates substantially from a regular value. This is an invaluable tool for use in "intermittent" electronic system failures.

8.5 Likely failures in proven systems

The following problems are arranged in order from most likely to least likely, top to bottom. This order has been determined largely from personal experience troubleshooting electrical and electronic problems in automotive, industry, and home applications. This order also assumes a circuit or system that has been proven to function as designed and has failed after substantial operation time. Problems experienced in newly assembled circuits and systems do not necessarily exhibit the same probabilities of occurrence.

8.5.1 Operator error

A frequent cause of system failure is error on the part of those human beings operating it. This cause of trouble is placed at the top of the list, but of course the actual likelihood depends largely on the particular individuals responsible for operation. When operator error is the cause of a failure, it is *unlikely* that it will be admitted prior to investigation. I do not mean to suggest that operators are incompetent and irresponsible – quite the contrary: these people are often your best teachers for learning system function and obtaining a history of failure – but the reality of human error cannot be overlooked. A positive attitude coupled with good interpersonal skills on the part of the troubleshooter goes a long way in troubleshooting when human error is the root cause of failure.

8.5.2 Bad wire connections

As incredible as this may sound to the new student of electronics, a high percentage of electrical and electronic system problems are caused by a very simple source of trouble: poor (i.e. open or shorted) wire connections. This is especially true when the environment is hostile, including such factors as high vibration and/or a corrosive atmosphere. Connection points found in any variety of plug-and-socket connector, terminal strip, or splice are at the greatest risk for failure. The category of "connections" also includes mechanical switch contacts, which can be thought of as a high-cycle connector. Improper wire termination lugs (such as a compression-style connector crimped on the end of a solid wire – a definite *faux pas*) can cause high-resistance connections after a period of trouble-free service.

It should be noted that connections in low-voltage systems tend to be far more troublesome than connections in high-voltage systems. The main reason for this is the effect of arcing across a

discontinuity (circuit break) in higher-voltage systems tends to blast away insulating layers of dirt and corrosion, and may even weld the two ends together if sustained long enough. Low-voltage systems tend not to generate such vigorous arcing across the gap of a circuit break, and also tend to be more sensitive to additional resistance in the circuit. Mechanical switch contacts used in low-voltage systems benefit from having the recommended minimum *wetting current* conducted through them to promote a healthy amount of arcing upon opening, even if this level of current is not necessary for the operation of other circuit components.

Although *open* failures tend to be more common than *shorted* failures, "shorts" still constitute a substantial percentage of wiring failure modes. Many shorts are caused by degradation of wire insulation. This, again, is especially true when the environment is hostile, including such factors as high vibration, high heat, high humidity, or high voltage. It is rare to find a mechanical switch contact that is failed shorted, except in the case of high-current contacts where contact "welding" may occur in overcurrent conditions. Shorts may also be caused by conductive buildup across terminal strip sections or the backs of printed circuit boards.

A common case of shorted wiring is the *ground fault*, where a conductor accidentally makes contact with either earth or chassis ground. This may change the voltage(s) present between other conductors in the circuit and ground, thereby causing bizarre system malfunctions and/or personnel hazard.

8.5.3 Power supply problems

These generally consist of tripped overcurrent protection devices or damage due to overheating. Although power supply circuitry is usually less complex than the circuitry being powered, and therefore should figure to be less prone to failure on that basis alone, it generally handles more power than any other portion of the system and therefore must deal with greater voltages and/or currents. Also, because of its relative design simplicity, a system's power supply may not receive the engineering attention it deserves, most of the engineering focus devoted to more glamorous parts of the system.

8.5.4 Active components

Active components (amplification devices) tend to fail with greater regularity than passive (non-amplifying) devices, due to their greater complexity and tendency to amplify overvoltage/overcurrent conditions. Semiconductor devices are notoriously prone to failure due to electrical transient (voltage/current surge) overloading and thermal (heat) overloading. Electron tube devices are far more resistant to both of these failure modes, but are generally more prone to mechanical failures due to their fragile construction.

8.5.5 Passive components

Non-amplifying components are the most rugged of all, their relative simplicity granting them a statistical advantage over active devices. The following list gives an approximate relation of failure probabilities (again, top being the most likely and bottom being the least likely):

- Capacitors (shorted), especially *electrolytic* capacitors. The paste electrolyte tends to lose moisture with age, leading to failure. Thin dielectric layers may be punctured by overvoltage transients.

- Diodes open (rectifying diodes) or shorted (Zener diodes).
- Inductor and transformer windings open or shorted to conductive core. Failures related to overheating (insulation breakdown) are easily detected by smell.
- Resistors open, almost never shorted. Usually this is due to overcurrent heating, although it is less frequently caused by overvoltage transient (arc-over) or physical damage (vibration or impact). Resistors may also change resistance value if overheated!

8.6 Likely failures in unproven systems

"All men are liable to error;"

John Locke

Whereas the last section deals with component failures in systems that have been successfully operating for some time, this section concentrates on the problems plaguing brand-new systems. In this case, failure modes are generally not of the aging kind, but are related to mistakes in design and assembly caused by human beings.

8.6.1 Wiring problems

In this case, bad connections are usually due to assembly error, such as connection to the wrong point or poor connector fabrication. Shorted failures are also seen, but usually involve misconnections (conductors inadvertently attached to grounding points) or wires pinched under box covers.

Another wiring-related problem seen in new systems is that of electrostatic or electromagnetic interference between different circuits by way of close wiring proximity. This kind of problem is easily created by routing sets of wires too close to each other (especially routing signal cables close to power conductors), and tends to be very difficult to identify and locate with test equipment.

8.6.2 Power supply problems

Blown fuses and tripped circuit breakers are likely sources of trouble, especially if the project in question is an addition to an already-functioning system. Loads may be larger than expected, resulting in overloading and subsequent failure of power supplies.

8.6.3 Defective components

In the case of a newly-assembled system, component fault probabilities are not as predictable as in the case of an operating system that fails with age. *Any* type of component – active or passive – may be found defective or of imprecise value "out of the box" with roughly equal probability, barring any specific sensitivities in shipping (i.e fragile vacuum tubes or electrostatically sensitive semiconductor components). Moreover, these types of failures are not always as easy to identify by sight or smell as an age- or transient-induced failure.

8.6.4 Improper system configuration

Increasingly seen in large systems using microprocessor-based components, "programming" issues can still plague non-microprocessor systems in the form of incorrect time-delay relay settings, limit switch calibrations, and drum switch sequences. Complex components having configuration "jumpers" or switches to control behavior may not be "programmed" properly.

Components may be used in a new system outside of their tolerable ranges. Resistors, for example, with too low of power ratings, or too great of tolerance, may have been installed. Sensors, instruments, and controlling mechanisms may be uncalibrated, or calibrated to the wrong ranges.

8.6.5 Design error

Perhaps the most difficult to pinpoint and the slowest to be recognized (especially by the chief designer) is the problem of design error, where the system fails to function simply because it *cannot* function as designed. This may be as trivial as the designer specifying the wrong components in a system, or as fundamental as a system not working due to the designer's improper knowledge of physics.

I once saw a turbine control system installed that used a low-pressure switch on the lubrication oil tubing to shut down the turbine if oil pressure dropped to an insufficient level. The oil pressure for lubrication was supplied by an oil pump turned by the turbine. When installed, the turbine refused to start. Why? Because when it was stopped, the oil pump was not turning, thus there was no oil pressure to lubricate the turbine. The low-oil-pressure switch detected this condition and the control system maintained the turbine in shutdown mode, preventing it from starting. This is a classic example of a design flaw, and it could only be corrected by a change in the system logic.

While most design flaws manifest themselves early in the operational life of the system, some remain hidden until just the right conditions exist to trigger the fault. These types of flaws are the most difficult to uncover, as the troubleshooter usually overlooks the possibility of design error due to the fact that the system is assumed to be "proven." The example of the turbine lubrication system was a design flaw impossible to ignore on start-up. An example of a "hidden" design flaw might be a faulty emergency coolant system for a machine, designed to remain inactive until certain abnormal conditions are reached – conditions which might never be experienced in the life of the system.

8.7 Potential pitfalls

Fallacious reasoning and poor interpersonal relations account for more failed or belabored troubleshooting efforts than any other impediments. With this in mind, the aspiring troubleshooter needs to be familiar with a few common troubleshooting mistakes.

Trusting that a brand-new component will always be good. While it is generally true that a new component will be in good condition, it is not *always* true. It is also possible that a component has been mis-labeled and may have the wrong value (usually this mis-labeling is a mistake made at the point of distribution or warehousing and not at the manufacturer, but again, *not always!*).

Not periodically checking your test equipment. This is especially true with battery-powered meters, as weak batteries may give spurious readings. When using meters to safety-check for dangerous voltage, remember to test the meter on a known source of voltage both *before* and *after* checking the circuit to be serviced, to make sure the meter is in proper operating condition.

Assuming there is only one failure to account for the problem. Single-failure system problems are ideal for troubleshooting, but sometimes failures come in multiple numbers. In some instances, the failure of one component may lead to a system condition that damages other components. Sometimes a component in marginal condition goes undetected for a long time, then when another component fails the system suffers from problems with *both* components.

Mistaking coincidence for causality. Just because two events occurred at nearly the same time does *not* necessarily mean one event *caused* the other! They may be both consequences of a common cause, or they may be totally unrelated! If possible, try to duplicate the same condition suspected to be the cause and see if the event suspected to be the coincidence happens again. If not, then there is either no causal relationship as assumed. This may mean there is no causal relationship between the two events whatsoever, or that there is a causal relationship, but just not the one you expected.

Self-induced blindness. After a long effort at troubleshooting a difficult problem, you may become tired and begin to overlook crucial clues to the problem. Take a break and let someone else look at it for a while. You will be amazed at what a difference this can make. On the other hand, it is generally a bad idea to solicit help at the start of the troubleshooting process. Effective troubleshooting involves complex, multi-level thinking, which is not easily communicated with others. More often than not, "team troubleshooting" takes more time and causes more frustration than doing it yourself. An exception to this rule is when the knowledge of the troubleshooters is complementary: for example, a technician who knows electronics but not machine operation, teamed with an operator who knows machine function but not electronics.

Failing to question the troubleshooting work of others on the same job. This may sound rather cynical and misanthropic, but it is sound scientific practice. Because it is easy to overlook important details, troubleshooting data received from another troubleshooter should be personally verified before proceeding. This is a common situation when troubleshooters "change shifts" and a technician takes over for another technician who is leaving before the job is done. It is important to exchange information, but do not assume the prior technician checked everything they said they did, or checked it perfectly. I've been hindered in my troubleshooting efforts on many occasions by failing to verify what someone else told me they checked.

Being pressured to "hurry up." When an important system fails, there will be pressure from other people to fix the problem as quickly as possible. As they say in business, "time is money." Having been on the receiving end of this pressure many times, I can understand the need for expedience. However, in many cases there is a higher priority: caution. If the system in question harbors great danger to life and limb, the pressure to "hurry up" may result in injury or death. At the very least, hasty repairs may result in further damage when the system is restarted. Most failures can be recovered or at least temporarily repaired in short time if approached intelligently. Improper "fixes" resulting in haste often lead to damage that *cannot* be recovered in short time, if

ever. If the potential for greater harm is present, the troubleshooter needs to politely address the pressure received from others, and maintain their perspective in the midst of chaos. Interpersonal skills are just as important in this realm as technical ability!

Finger-pointing. It is all too easy to blame a problem on someone else, for reasons of ignorance, pride, laziness, or some other unfortunate facet of human nature. When the responsibility for system maintenance is divided into departments or work crews, troubleshooting efforts are often hindered by blame cast between groups. "It's a mechanical problem . . . it's an electrical problem . . . it's an instrument problem . . ." ad infinitum, ad nauseum, is all too common in the workplace. I have found that a positive attitude does more to quench the fires of blame than anything else.

On one particular job, I was summoned to fix a problem in a hydraulic system assumed to be related to the electronic metering and controls. My troubleshooting isolated the source of trouble to a faulty control valve, which was the domain of the millwright (mechanical) crew. I knew that the millwright on shift was a contentious person, so I expected trouble if I simply passed the problem on to his department. Instead, I politely explained to him and his supervisor the nature of the problem as well as a brief synopsis of my reasoning, then proceeded to help him replace the faulty valve, even though it wasn't "my" responsibility to do so. As a result, the problem was fixed very quickly, and I gained the respect of the millwright.

8.8 Contributors

Contributors to this chapter are listed in chronological order of their contributions, from most recent to first. See Appendix 2 (Contributor List) for dates and contact information.

Alejandro Gamero Divasto (January 2002): contributed troubleshooting tips regarding potential hazards of swapping two similar components, avoiding pressure placed on the troubleshooter, perils of "team" troubleshooting, wisdom of recording system history, operator error as a cause of failure, and the perils of finger-pointing.

Chapter 9

CIRCUIT SCHEMATIC SYMBOLS

9.1 Wires and connections

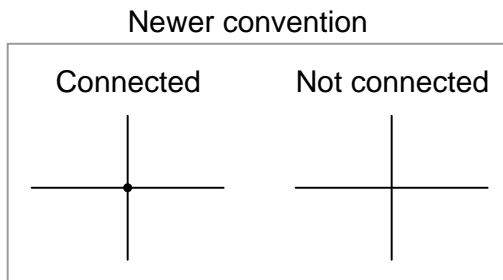
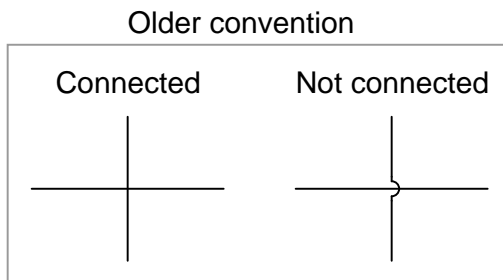

Older electrical schematics showed connecting wires crossing, while non-connecting wires "jumped" over each other with little half-circle marks. Newer electrical schematics show connecting wires joining with a dot, while non-connecting wires cross with no dot. However, some people still use the older convention of connecting wires crossing with no dot, which may create confusion.

For this reason, I opt to use a hybrid convention, with connecting wires unambiguously connected by a dot, and non-connecting wires unambiguously "jumping" over one another with a half-circle

mark. While this may be frowned upon by some, it leaves no room for interpretational error: in each case, the intent is clear and unmistakable:

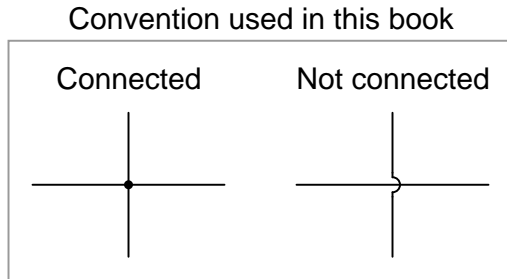

9.2 Power sources

DC voltage

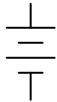

DC voltage



AC voltage



Variable
DC voltage

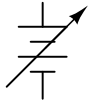

*A diagonal arrow
represents variability
for **any** component!*

DC current

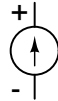

Generator

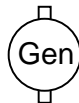

AC current



9.3 Resistors

Fixed-value

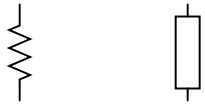

Rheostat



Potentiometer

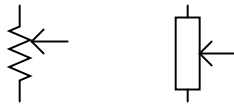

Tapped



Thermistor



Photoresistor

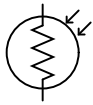

9.4 Capacitors

Non-polarized

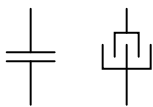

Polarized (top positive)

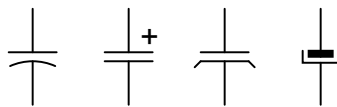

Variable

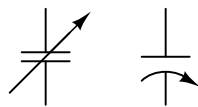

9.5 Inductors

Fixed-value

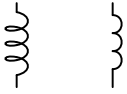

Iron core



Variable



Variac



Tapped



9.6 Mutual inductors

Transformer



Step-up/step-down transformer

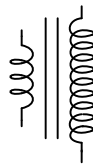

Variac



Transformer



Transformer

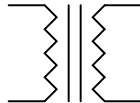

Transformer



Saturable reactor

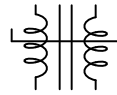

Synchro

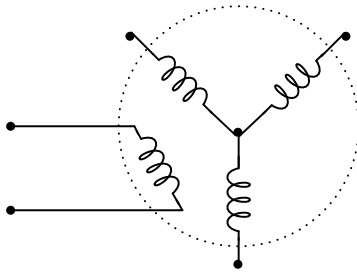

Synchro

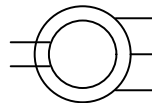

9.7 Switches, hand actuated

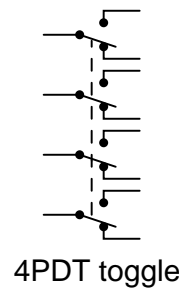
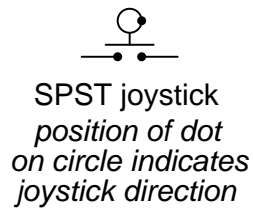
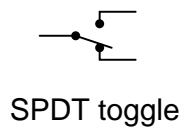
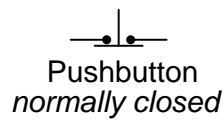
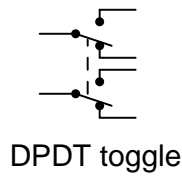
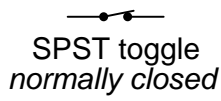
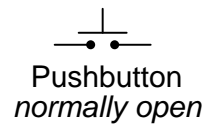
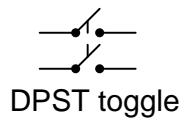
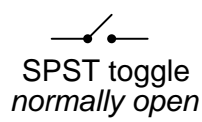

9.8 Switches, process actuated

Normally open shown on top; normally closed on bottom

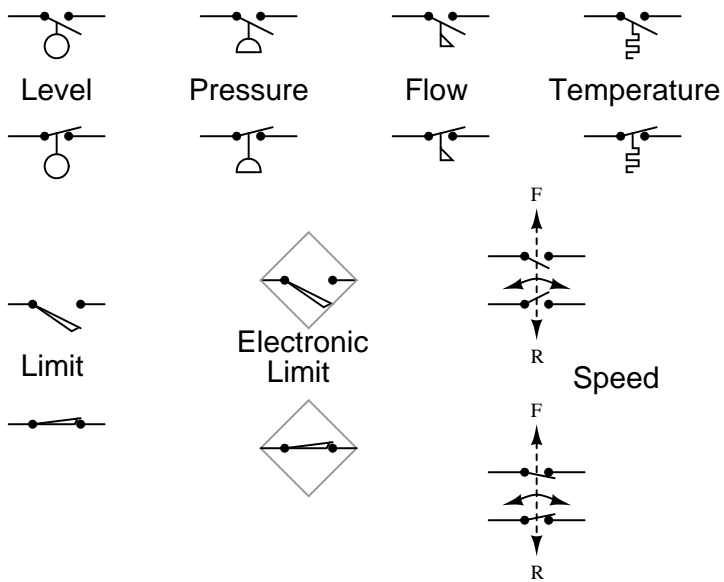

It is very important to keep in mind that the "normal" contact status of a process-actuated switch refers to its status when the process is absent and/or inactive, *not* "normal" in the sense of process conditions as expected during routine operation. For instance, a *normally-closed* low-flow detection switch installed on a coolant pipe will be maintained in the actuated state (open) when there is regular coolant flow through the pipe. If the coolant flow stops, the flow switch will go to its "normal" (unactuated) status of closed.

A *limit* switch is one actuated by contact with a moving machine part. An *electronic limit* switch senses mechanical motion, but does so using light, magnetic fields, or other non-contact means.

9.9 Switches, electrically actuated (relays)

Relay components, "ladder logic" notation style

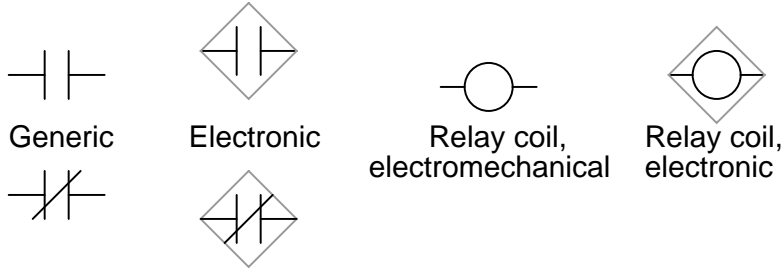

Relays, electronic schematic notation style



9.10 Connectors

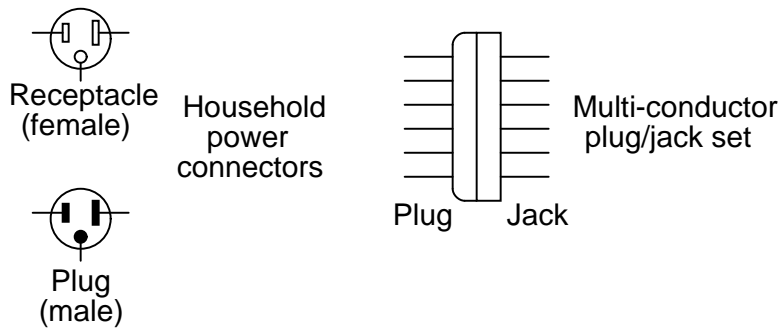

9.11 Diodes

Generic



Schottky



Shockley

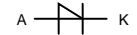

Constant current



Zener



Light-emitting



Photo-



Step recovery



Tunnel



Varactor



PIN



Vacuum tube

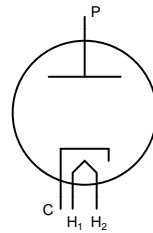

A = Anode
K = Cathode

9.12 Transistors, bipolar

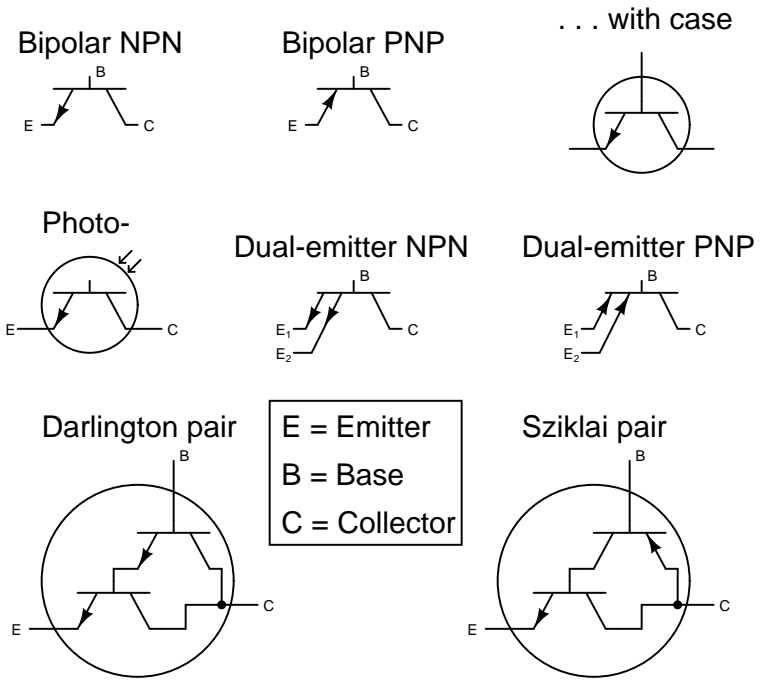

9.13 Transistors, junction field-effect (JFET)

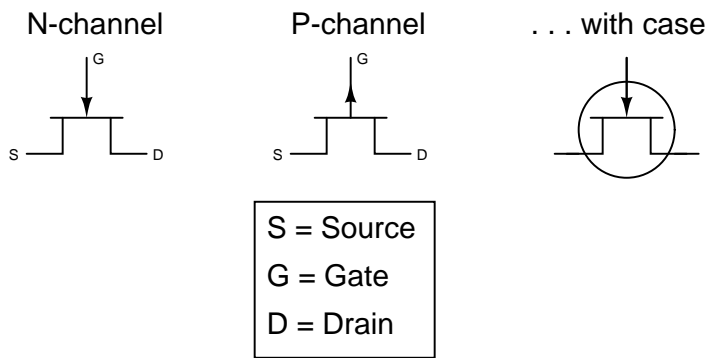

9.14 Transistors, insulated-gate field-effect (IGFET or MOS-FET)

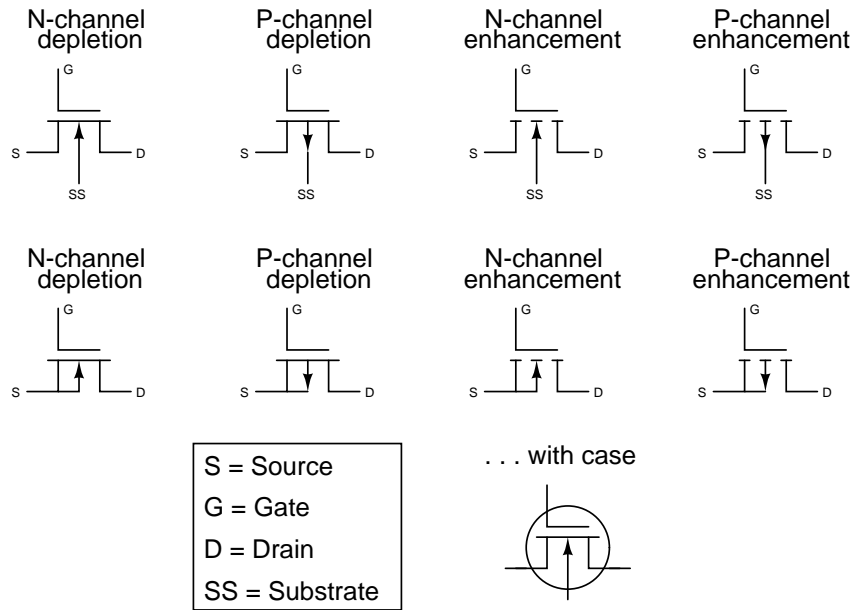

9.15 Transistors, hybrid

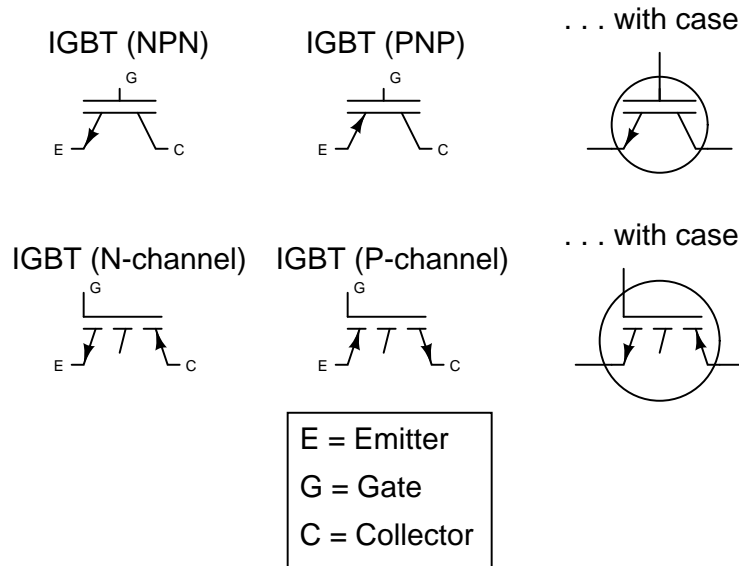

9.16 Thyristors

Shockley

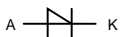

DIAC



SCR

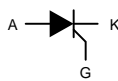

LASCR

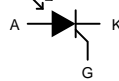

TRIAC

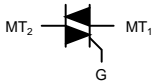

Opto-TRIAC

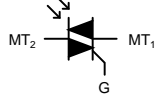

SCS

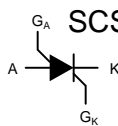

GCS

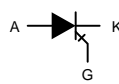

GTO

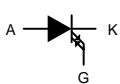

UJT

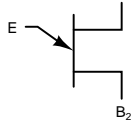

<p>A = Anode K = Cathode G = Gate MT = Main Terminal E = Emitter B = Base</p>
--

9.17 Integrated circuits

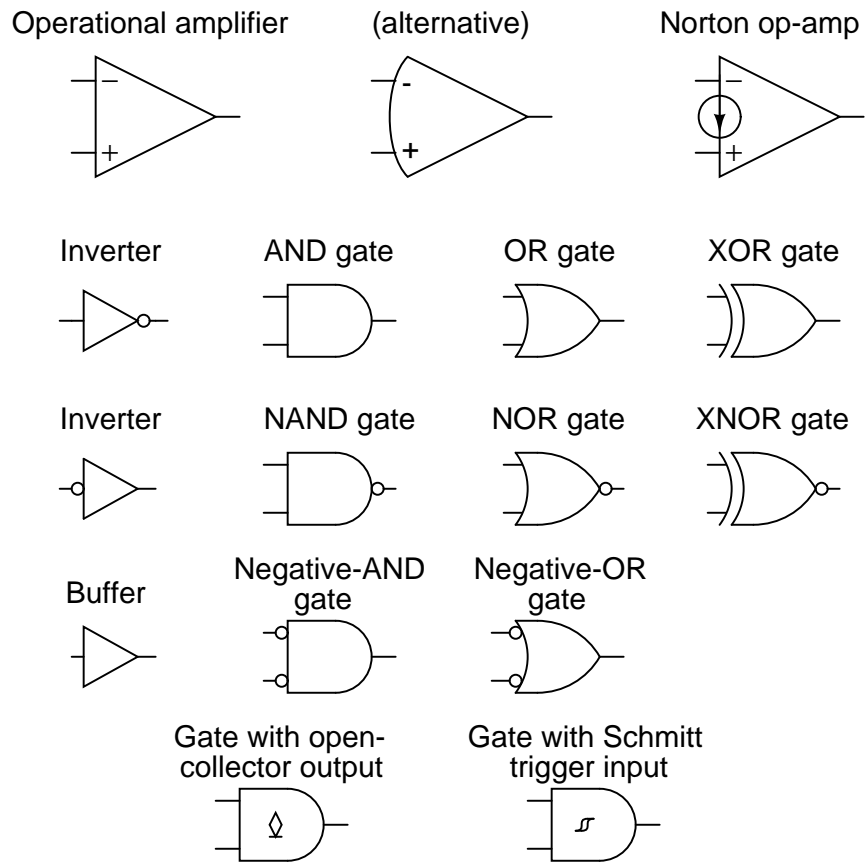

S-R Latch

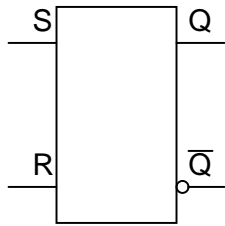

Enabled S-R Latch

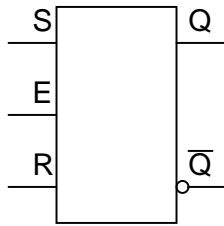

S-R Flip-flop

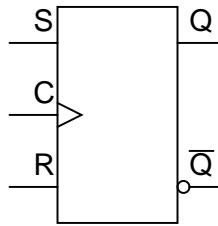

D Latch

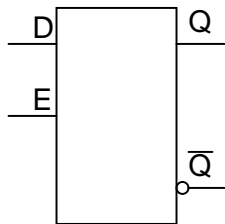

D Flip-flop

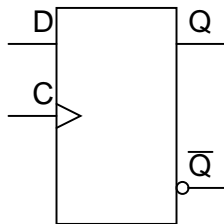

J-K Flip-flop

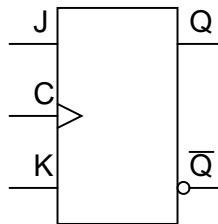

9.18 Electron tubes

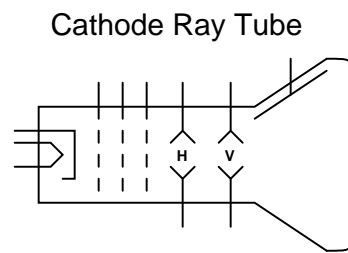
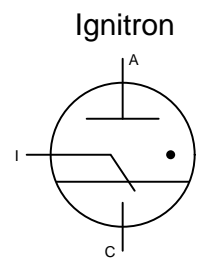
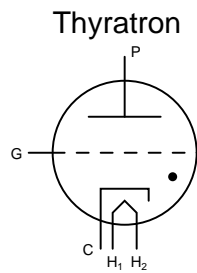
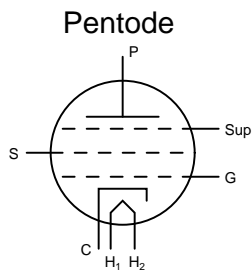
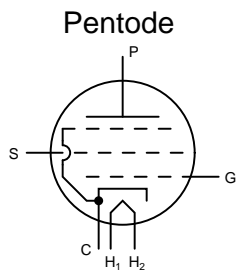
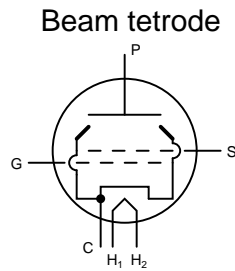
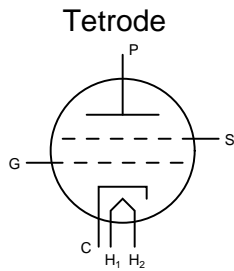
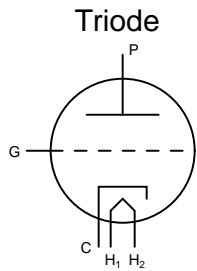
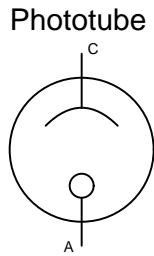
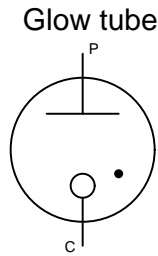
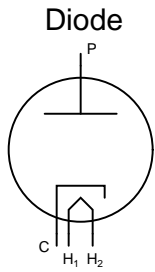

P = Plate	S = Screen
G = Grid	A = Anode
C = Cathode	H = Heater
I = Ignitor	Sup = Suppressor

Chapter 10

PERIODIC TABLE OF THE ELEMENTS

10.1 Table (landscape view)

Periodic Table of the Elements

H 1 Hydrogen 1.00794 1s ¹																	He 2 Helium 4.00260 1s ²				
Li 3 Lithium 6.941 2s ¹	Be 4 Beryllium 9.012182 2s ²															B 5 Boron 10.81 2p ¹	C 6 Carbon 12.011 2p ²	N 7 Nitrogen 14.0067 2p ³	O 8 Oxygen 15.9994 2p ⁴	F 9 Fluorine 18.9984 2p ⁵	Ne 10 Neon 20.179 2p ⁶
Na 11 Sodium 22.989768 3s ¹	Mg 12 Magnesium 24.3050 3s ²															Al 13 Aluminum 26.9815 3p ¹	Si 14 Silicon 28.0855 3p ²	P 15 Phosphorus 30.9738 3p ³	S 16 Sulfur 32.06 3p ⁴	Cl 17 Chlorine 35.453 3p ⁵	Ar 18 Argon 39.948 3p ⁶
<i>Metals</i>																					
K 19 Potassium 39.0983 4s ¹	Ca 20 Calcium 40.078 4s ²	Sc 21 Scandium 44.955910 3d ¹ 4s ²	Ti 22 Titanium 47.88 3d ² 4s ²	V 23 Vanadium 50.9415 3d ³ 4s ²	Cr 24 Chromium 51.9961 3d ⁵ 4s ¹	Mn 25 Manganese 54.93805 3d ⁵ 4s ²	Fe 26 Iron 55.847 3d ⁶ 4s ²	Co 27 Cobalt 58.93320 3d ⁷ 4s ²	Ni 28 Nickel 58.69 3d ⁸ 4s ²	Cu 29 Copper 63.546 3d ¹⁰ 4s ¹	Zn 30 Zinc 65.39 3d ¹⁰ 4s ²	Ga 31 Gallium 69.723 4p ¹	Ge 32 Germanium 72.61 4p ²	As 33 Arsenic 74.92159 4p ³	Se 34 Selenium 78.96 4p ⁴	Br 35 Bromine 79.904 4p ⁵	Kr 36 Krypton 83.80 4p ⁶				
Rb 37 Rubidium 85.4678 5s ¹	Sr 38 Strontium 87.62 5s ²	Y 39 Yttrium 88.90585 4d ¹ 5s ²	Zr 40 Zirconium 91.224 4d ² 5s ²	Nb 41 Niobium 92.90638 4d ⁴ 5s ¹	Mo 42 Molybdenum 95.94 4d ⁵ 5s ¹	Tc 43 Technetium (98) 4d ⁵ 5s ²	Ru 44 Ruthenium 101.07 4d ⁷ 5s ¹	Rh 45 Rhodium 102.90550 4d ⁸ 5s ¹	Pd 46 Palladium 106.42 4d ¹⁰ 5s ⁰	Ag 47 Silver 107.8682 4d ¹⁰ 5s ¹	Cd 48 Cadmium 112.411 4d ¹⁰ 5s ²	In 49 Indium 114.82 5p ¹	Sn 50 Tin 118.710 5p ²	Sb 51 Antimony 121.75 5p ³	Te 52 Tellurium 127.60 5p ⁴	I 53 Iodine 126.905 5p ⁵	Xe 54 Xenon 131.30 5p ⁶				
Cs 55 Cesium 132.90543 6s ¹	Ba 56 Barium 137.327 6s ²	57 - 71 <i>Lanthanide series</i>		Hf 72 Hafnium 178.49 5d ² 6s ²	Ta 73 Tantalum 180.9479 5d ³ 6s ²	W 74 Tungsten 183.85 5d ⁴ 6s ²	Re 75 Rhenium 186.207 5d ⁵ 6s ²	Os 76 Osmium 190.2 5d ⁶ 6s ²	Ir 77 Iridium 192.22 5d ⁷ 6s ²	Pt 78 Platinum 195.08 5d ⁹ 6s ¹	Au 79 Gold 196.96654 5d ¹⁰ 6s ¹	Hg 80 Mercury 200.59 5d ¹⁰ 6s ²	Tl 81 Thallium 204.3833 6p ¹	Pb 82 Lead 207.2 6p ²	Bi 83 Bismuth 208.98037 6p ³	Po 84 Polonium (209) 6p ⁴	At 85 Astatine (210) 6p ⁵	Rn 86 Radon (222) 6p ⁶			
Fr 87 Francium (223) 7s ¹	Ra 88 Radium (226) 7s ²	89 - 103 <i>Actinide series</i>		Unq 104 Unnilquadium (261) 6d ² 7s ²	Unp 105 Unnilpentium (262) 6d ³ 7s ²	Unh 106 Unnilhexium (263) 6d ⁴ 7s ²	Uns 107 Unnilseptium (262)	108	109												

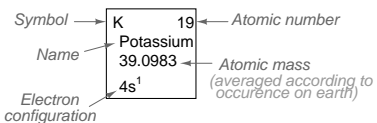
*Metalloids**Nonmetals*

<i>Lanthanide series</i>		La 57 Lanthanum 138.9055 5d ¹ 6s ²	Ce 58 Cerium 140.115 4f ¹ 5d ¹ 6s ²	Pr 59 Praseodymium 140.90765 4f ³ 6s ²	Nd 60 Neodymium 144.24 4f ⁴ 6s ²	Pm 61 Promethium (145) 4f ⁵ 6s ²	Sm 62 Samarium 150.36 4f ⁶ 6s ²	Eu 63 Europium 151.965 4f ⁷ 6s ²	Gd 64 Gadolinium 157.25 4f ⁷ 5d ¹ 6s ²	Tb 65 Terbium 158.92534 4f ⁹ 6s ²	Dy 66 Dysprosium 162.50 4f ¹⁰ 6s ²	Ho 67 Holmium 164.93032 4f ¹¹ 6s ²	Er 68 Erbium 167.26 4f ¹² 6s ²	Tm 69 Thulium 168.93421 4f ¹³ 6s ²	Yb 70 Ytterbium 173.04 4f ¹⁴ 6s ²	Lu 71 Lutetium 174.967 4f ¹⁴ 5d ¹ 6s ²
<i>Actinide series</i>		Ac 89 Actinium (227) 6d ¹ 7s ²	Th 90 Thorium 232.0381 6d ² 7s ²	Pa 91 Protactinium 231.03588 5f ² 6d ¹ 7s ²	U 92 Uranium 238.0289 5f ³ 6d ¹ 7s ²	Np 93 Neptunium (237) 5f ⁴ 6d ¹ 7s ²	Pu 94 Plutonium (244) 5f ⁶ 6d ⁰ 7s ²	Am 95 Americium (243) 5f ⁷ 6d ⁰ 7s ²	Cm 96 Curium (247) 5f ⁷ 6d ¹ 7s ²	Bk 97 Berkelium (247) 5f ⁹ 6d ⁰ 7s ²	Cf 98 Californium (251) 5f ¹⁰ 6d ⁰ 7s ²	Es 99 Einsteinium (252) 5f ¹¹ 6d ⁰ 7s ²	Fm 100 Fermium (257) 5f ¹² 6d ⁰ 7s ²	Md 101 Mendelevium (258) 5f ¹³ 6d ⁰ 7s ²	No 102 Nobelium (259) 6d ⁰ 7s ²	Lr 103 Lawrencium (260) 6d ¹ 7s ²

10.2 Table (portrait view)

Periodic Table of the Elements

Metals																		Metalloids		Nonmetals					
H 1 Hydrogen 1.00794 1s ¹																	He 2 Helium 4.00260 1s ²								
Li 3 Lithium 6.941 2s ¹	Be 4 Beryllium 9.012182 2s ²																	B 5 Boron 10.81 2p ¹	C 6 Carbon 12.011 2p ²	N 7 Nitrogen 14.0067 2p ³	O 8 Oxygen 15.9994 2p ⁴	F 9 Fluorine 18.9984 2p ⁵	Ne 10 Neon 20.179 2p ⁶		
Na 11 Sodium 22.989768 3s ¹	Mg 12 Magnesium 24.3050 3s ²																	Al 13 Aluminum 26.9815 3p ¹	Si 14 Silicon 28.0855 3p ²	P 15 Phosphorus 30.9738 3p ³	S 16 Sulfur 32.06 3p ⁴	Cl 17 Chlorine 35.453 3p ⁵	Ar 18 Argon 39.948 3p ⁶		
K 19 Potassium 39.0983 4s ¹	Ca 20 Calcium 40.078 4s ²	Sc 21 Scandium 44.955910 3d ¹ 4s ²	Ti 22 Titanium 47.88 3d ² 4s ²	V 23 Vanadium 50.9415 3d ³ 4s ²	Cr 24 Chromium 51.9961 3d ⁵ 4s ¹	Mn 25 Manganese 54.93805 3d ⁵ 4s ²	Fe 26 Iron 55.847 3d ⁶ 4s ²	Co 27 Cobalt 58.93320 3d ⁷ 4s ²	Ni 28 Nickel 58.69 3d ⁸ 4s ²	Cu 29 Copper 63.546 3d ¹⁰ 4s ¹	Zn 30 Zinc 65.39 3d ¹⁰ 4s ²	Ga 31 Gallium 69.723 4p ¹	Ge 32 Germanium 72.61 4p ²	As 33 Arsenic 74.92159 4p ³	Se 34 Selenium 78.96 4p ⁴	Br 35 Bromine 79.904 4p ⁵	Kr 36 Krypton 83.80 4p ⁶								
Rb 37 Rubidium 85.4678 5s ¹	Sr 38 Strontium 87.62 5s ²	Y 39 Yttrium 88.90585 4d ¹ 5s ²	Zr 40 Zirconium 91.224 4d ² 5s ²	Nb 41 Niobium 92.90638 4d ⁴ 5s ¹	Mo 42 Molybdenum 95.94 4d ⁵ 5s ¹	Tc 43 Technetium (98) 4d ⁵ 5s ²	Ru 44 Ruthenium 101.07 4d ⁷ 5s ¹	Rh 45 Rhodium 102.90550 4d ⁸ 5s ¹	Pd 46 Palladium 106.42 4d ¹⁰ 5s ⁰	Ag 47 Silver 107.8682 4d ¹⁰ 5s ¹	Cd 48 Cadmium 112.411 4d ¹⁰ 5s ²	In 49 Indium 114.82 5p ¹	Sn 50 Tin 118.710 5p ²	Sb 51 Antimony 121.75 5p ³	Te 52 Tellurium 127.60 5p ⁴	I 53 Iodine 126.905 5p ⁵	Xe 54 Xenon 131.30 5p ⁶								
Cs 55 Cesium 132.90543 6s ¹	Ba 56 Barium 137.327 6s ²	Lanthanide series 5f ⁷ 6s ²		Hf 72 Hafnium 178.49 5d ² 6s ²	Ta 73 Tantalum 180.9479 5d ³ 6s ²	W 74 Tungsten 183.85 5d ⁴ 6s ²	Re 75 Rhenium 186.207 5d ⁵ 6s ²	Os 76 Osmium 190.2 5d ⁶ 6s ²	Ir 77 Iridium 192.22 5d ⁷ 6s ²	Pt 78 Platinum 195.08 5d ⁹ 6s ¹	Au 79 Gold 196.96654 5d ¹⁰ 6s ¹	Hg 80 Mercury 200.59 5d ¹⁰ 6s ²	Tl 81 Thallium 204.3833 6p ¹	Pb 82 Lead 207.2 6p ²	Bi 83 Bismuth 208.98037 6p ³	Po 84 Polonium (209) 6p ⁴	At 85 Astatine (210) 6p ⁵	Rn 86 Radon (222) 6p ⁶							
Fr 87 Francium (223) 7s ¹	Ra 88 Radium (226) 7s ²	Actinide series 6d ¹ 7s ²		Unq 104 Unnilquadium (261) 6d ⁷ 7s ²	Unp 105 Unnilpentium (262) 6d ⁷ 7s ²	Unh 106 Unnilhexium (263) 6d ⁷ 7s ²	Uns 107 Unnilseptium (262) 6d ⁷ 7s ²	108	109																
Lanthanide series		La 57 Lanthanum 138.9055 5d ¹ 6s ²	Ce 58 Cerium 140.115 4f ¹ 5d ¹ 6s ²	Pr 59 Praseodymium 140.90765 4f ³ 6s ²	Nd 60 Neodymium 144.24 4f ⁴ 6s ²	Pm 61 Promethium (145) 4f ⁵ 6s ²	Sm 62 Samarium 150.36 4f ⁶ 6s ²	Eu 63 Europium 151.965 4f ⁷ 6s ²	Gd 64 Gadolinium 157.25 4f ⁷ 5d ¹ 6s ²	Tb 65 Terbium 158.92534 4f ⁹ 6s ²	Dy 66 Dysprosium 162.50 4f ¹⁰ 6s ²	Ho 67 Holmium 164.93032 4f ¹¹ 6s ²	Er 68 Erbium 167.26 4f ¹² 6s ²	Tm 69 Thulium 168.93421 4f ¹³ 6s ²	Yb 70 Ytterbium 173.04 4f ¹⁴ 6s ²	Lu 71 Lutetium 174.967 4f ¹⁴ 5d ¹ 6s ²									
Actinide series		Ac 89 Actinium (227) 6d ¹ 7s ²	Th 90 Thorium 232.0381 6d ² 7s ²	Pa 91 Protactinium 231.03688 5f ² 6d ¹ 7s ²	U 92 Uranium 238.02891 5f ³ 6d ¹ 7s ²	Np 93 Neptunium (237) 5f ⁴ 6d ¹ 7s ²	Pu 94 Plutonium (244) 5f ⁶ 6d ¹ 7s ²	Am 95 Americium (243) 5f ⁷ 6d ¹ 7s ²	Cm 96 Curium (247) 5f ⁷ 6d ¹ 7s ²	Bk 97 Berkelium (247) 5f ⁹ 6d ¹ 7s ²	Cf 98 Californium (251) 5f ¹⁰ 6d ¹ 7s ²	Es 99 Einsteinium (252) 5f ¹¹ 6d ¹ 7s ²	Fm 100 Fermium (257) 5f ¹² 6d ¹ 7s ²	Md 101 Mendelevium (258) 5f ¹³ 6d ¹ 7s ²	No 102 Nobelium (259) 6d ¹ 7s ²	Lr 103 Lawrencium (260) 6d ¹ 7s ²									

10.3 Data

Atomic masses shown in parentheses indicate the *most stable* isotope (longest half-life) known.

Electron configuration data was taken from Douglas C. Giancoli's Physics, 3rd edition. Average atomic masses were taken from Kenneth W. Whitten's, Kenneth D. Gailey's, and Raymond E. Davis' General Chemistry, 3rd edition. In the latter book, the masses were specified as 1985 IUPAC values.

Chapter 11

ABOUT THIS BOOK

11.1 Purpose

They say that necessity is the mother of invention. At least in the case of this book, that adage is true. As an industrial electronics instructor, I was forced to use a sub-standard textbook during my first year of teaching. My students were daily frustrated with the many typographical errors and obscure explanations in this book, having spent much time at home struggling to comprehend the material within. Worse yet were the many incorrect answers in the back of the book to selected problems. Adding insult to injury was the \$100+ price.

Contacting the publisher proved to be an exercise in futility. Even though the particular text I was using had been in print and in popular use for a couple of years, they claimed my complaint was the first they'd ever heard. My request to review the draft for the next edition of their book was met with disinterest on their part, and I resolved to find an alternative text.

Finding a suitable alternative was more difficult than I had imagined. Sure, there were plenty of texts in print, but the really good books seemed a bit too heavy on the math and the less intimidating books omitted a lot of information I felt was important. Some of the best books were out of print, and those that were still being printed were quite expensive.

It was out of frustration that I compiled *Lessons in Electric Circuits* from notes and ideas I had been collecting for years. My primary goal was to put readable, high-quality information into the hands of my students, but a secondary goal was to make the book as affordable as possible. Over the years, I had experienced the benefit of receiving free instruction and encouragement in my pursuit of learning electronics from many people, including several teachers of mine in elementary and high school. Their selfless assistance played a key role in my own studies, paving the way for a rewarding career and fascinating hobby. If only I could extend the gift of their help by giving to other people what they gave to me . . .

So, I decided to make the book freely available. More than that, I decided to make it "open," following the same development model used in the making of free software (most notably the various UNIX utilities released by the Free Software Foundation, and the Linux operating system, whose fame is growing even as I write). The goal was to copyright the text – so as to protect my authorship – but expressly allow anyone to distribute and/or modify the text to suit their own needs with a minimum of legal encumbrance. This willful and formal revoking of standard distribution limitations

under copyright is whimsically termed *copyleft*. Anyone can "copyleft" their creative work simply by appending a notice to that effect on their work, but several Licenses already exist, covering the fine legal points in great detail.

The first such License I applied to my work was the GPL – General Public License – of the Free Software Foundation (GNU). The GPL, however, is intended to copyleft works of computer software, and although its introductory language is broad enough to cover works of text, its wording is not as clear as it could be for that application. When other, less specific copyleft Licenses began appearing within the free software community, I chose one of them (the Design Science License, or DSL) as the official notice for my project.

In "copylefting" this text, I guaranteed that no instructor would be limited by a text insufficient for their needs, as I had been with error-ridden textbooks from major publishers. I'm sure this book in its initial form will not satisfy everyone, but anyone has the freedom to change it, leveraging my efforts to suit variant and individual requirements. For the beginning student of electronics, learn what you can from this book, editing it as you feel necessary if you come across a useful piece of information. Then, if you pass it on to someone else, you will be giving them something better than what you received. For the instructor or electronics professional, feel free to use this as a reference manual, adding or editing to your heart's content. The only "catch" is this: if you plan to distribute your modified version of this text, you must give credit where credit is due (to me, the original author, and anyone else whose modifications are contained in your version), and you must ensure that whoever you give the text to is aware of their freedom to similarly share and edit the text. The next chapter covers this process in more detail.

It must be mentioned that although I strive to maintain technical accuracy in all of this book's content, the subject matter is broad and harbors many potential dangers. Electricity maims and kills without provocation, and deserves the utmost respect. I strongly encourage experimentation on the part of the reader, but only with circuits powered by small batteries where there is no risk of electric shock, fire, explosion, etc. High-power electric circuits should be left to the care of trained professionals! The Design Science License clearly states that neither I nor any contributors to this book bear any liability for what is done with its contents.

11.2 The use of SPICE

One of the best ways to learn how things work is to follow the inductive approach: to observe specific instances of things working and derive general conclusions from those observations. In science education, labwork is the traditionally accepted venue for this type of learning, although in many cases labs are designed by educators to reinforce principles previously learned through lecture or textbook reading, rather than to allow the student to learn on their own through a truly exploratory process.

Having taught myself most of the electronics that I know, I appreciate the sense of frustration students may have in teaching themselves from books. Although electronic components are typically inexpensive, not everyone has the means or opportunity to set up a laboratory in their own homes, and when things go wrong there's no one to ask for help. Most textbooks seem to approach the task of education from a deductive perspective: tell the student how things are supposed to work, then apply those principles to specific instances that the student may or may not be able to explore by themselves. The inductive approach, as useful as it is, is hard to find in the pages of a book.

However, textbooks don't have to be this way. I discovered this when I started to learn a

computer program called SPICE. It is a text-based piece of software intended to model circuits and provide analyses of voltage, current, frequency, etc. Although nothing is quite as good as building real circuits to gain knowledge in electronics, computer simulation is an excellent alternative. In learning how to use this powerful tool, I made a discovery: SPICE could be used within a textbook to present circuit simulations to allow students to "observe" the phenomena for themselves. This way, the readers could learn the concepts inductively (by interpreting SPICE's output) as well as deductively (by interpreting my explanations). Furthermore, in seeing SPICE used over and over again, they should be able to understand how to use it themselves, providing a perfectly safe means of experimentation on their own computers with circuit simulations of their own design.

Another advantage to including computer analyses in a textbook is the empirical verification it adds to the concepts presented. Without demonstrations, the reader is left to take the author's statements on faith, trusting that what has been written is indeed accurate. The problem with faith, of course, is that it is only as good as the authority in which it is placed and the accuracy of interpretation through which it is understood. Authors, like all human beings, are liable to err and/or communicate poorly. With demonstrations, however, the reader can immediately see for themselves that what the author describes is indeed true. Demonstrations also serve to clarify the meaning of the text with concrete examples.

SPICE is introduced early in volume I (DC) of this book series, and hopefully in a gentle enough way that it doesn't create confusion. For those wishing to learn more, a chapter in this volume (volume V) contains an overview of SPICE with many example circuits. There may be more flashy (graphic) circuit simulation programs in existence, but SPICE is free, a virtue complementing the charitable philosophy of this book very nicely.

11.3 Acknowledgements

First, I wish to thank my wife, whose patience during those many and long evenings (and weekends!) of typing has been extraordinary.

I also wish to thank those whose open-source software development efforts have made this endeavor all the more affordable and pleasurable. The following is a list of various free computer software used to make this book, and the respective programmers:

- *GNU/Linux* Operating System – Linus Torvalds, Richard Stallman, and a host of others too numerous to mention.
- *Vim* text editor – Bram Moolenaar and others.
- *Xcircuit* drafting program – Tim Edwards.
- *SPICE* circuit simulation program – too many contributors to mention.
- \TeX text processing system – Donald Knuth and others.
- *Texinfo* document formatting system – Free Software Foundation.
- \LaTeX document formatting system – Leslie Lamport and others.
- *Gimp* image manipulation program – too many contributors to mention.

Appreciation is also extended to Robert L. Boylestad, whose first edition of *Introductory Circuit Analysis* taught me more about electric circuits than any other book. Other important texts in my electronics studies include the 1939 edition of *The "Radio" Handbook*, Bernard Grob's second edition of *Introduction to Electronics I*, and Forrest Mims' original *Engineer's Notebook*.

Thanks to the staff of the Bellingham Antique Radio Museum, who were generous enough to let me terrorize their establishment with my camera and flash unit.

I wish to specifically thank Jeffrey Elkner and all those at Yorktown High School for being willing to host my book as part of their Open Book Project, and to make the first effort in contributing to its form and content. Thanks also to David Sweet (website: (<http://www.andamooka.org>)) and Ben Crowell (website: (<http://www.lightandmatter.com>)) for providing encouragement, constructive criticism, and a wider audience for the online version of this book.

Thanks to Michael Stutz for drafting his Design Science License, and to Richard Stallman for pioneering the concept of copyleft.

Last but certainly not least, many thanks to my parents and those teachers of mine who saw in me a desire to learn about electricity, and who kindled that flame into a passion for discovery and intellectual adventure. I honor you by helping others as you have helped me.

Tony Kuphaldt, July 2001

"A candle loses nothing of its light when lighting another"

Kahlil Gibran

Chapter 12

CONTRIBUTOR LIST

12.1 How to contribute to this book

As a copylefted work, this book is open to revision and expansion by any interested parties. The only "catch" is that credit must be given where credit is due. This *is* a copyrighted work: it is *not* in the public domain!

If you wish to cite portions of this book in a work of your own, you must follow the same guidelines as for any other copyrighted work. Here is a sample from the Design Science License:

```
The Work is copyright the Author. All rights to the Work are reserved
by the Author, except as specifically described below. This License
describes the terms and conditions under which the Author permits you
to copy, distribute and modify copies of the Work.
```

```
In addition, you may refer to the Work, talk about it, and (as
dictated by "fair use") quote from it, just as you would any
copyrighted material under copyright law.
```

```
Your right to operate, perform, read or otherwise interpret and/or
execute the Work is unrestricted; however, you do so at your own risk,
because the Work comes WITHOUT ANY WARRANTY -- see Section 7 ("NO
WARRANTY") below.
```

If you wish to modify this book in any way, you must document the nature of those modifications in the "Credits" section along with your name, and ideally, information concerning how you may be contacted. Again, the Design Science License:

```
Permission is granted to modify or sample from a copy of the Work,
producing a derivative work, and to distribute the derivative work
under the terms described in the section for distribution above,
provided that the following terms are met:
```

(a) The new, derivative work is published under the terms of this License.

(b) The derivative work is given a new name, so that its name or title can not be confused with the Work, or with a version of the Work, in any way.

(c) Appropriate authorship credit is given: for the differences between the Work and the new derivative work, authorship is attributed to you, while the material sampled or used from the Work remains attributed to the original Author; appropriate notice must be included with the new work indicating the nature and the dates of any modifications of the Work made by you.

Given the complexities and security issues surrounding the maintenance of files comprising this book, it is recommended that you submit any revisions or expansions to the original author (Tony R. Kuphaldt). You are, of course, welcome to modify this book directly by editing your own personal copy, but we would all stand to benefit from your contributions if your ideas were incorporated into the online “master copy” where all the world can see it.

12.2 Credits

All entries arranged in alphabetical order of surname. Major contributions are listed by individual name with some detail on the nature of the contribution(s), date, contact info, etc. Minor contributions (typo corrections, etc.) are listed by name only for reasons of brevity. Please understand that when I classify a contribution as “minor,” it is in no way inferior to the effort or value of a “major” contribution, just smaller in the sense of less text changed. Any and all contributions are gratefully accepted. I am indebted to all those who have given freely of their own knowledge, time, and resources to make this a better book!

12.2.1 Alejandro Gamero Divasto

- **Date(s) of contribution(s):** January 2002
- **Nature of contribution:** Suggestions related to troubleshooting: caveat regarding swapping two similar components as a troubleshooting tool; avoiding pressure placed on the troubleshooter; perils of “team” troubleshooting; wisdom of recording system history; operator error as a cause of failure; and the perils of finger-pointing.

12.2.2 Tony R. Kuphaldt

- **Date(s) of contribution(s):** 1996 to present
- **Nature of contribution:** Original author.
- **Contact at:** liec0@lycos.com

12.2.3 Your name here

- **Date(s) of contribution(s):** Month and year of contribution
- **Nature of contribution:** Insert text here, describing how you contributed to the book.
- **Contact at:** my_email@provider.net

12.2.4 Typo corrections and other “minor” contributions

- *The students of Bellingham Technical College’s Instrumentation program.*
- **Don Stalkowski** (June 2002) Technical help with PostScript-to-PDF file format conversion.
- **Joseph Teichman** (June 2002) Suggestion and technical help regarding use of PNG images instead of JPEG.

Chapter 13

DESIGN SCIENCE LICENSE

Copyright © 1999-2000 Michael Stutz stutz@dsl.org

Verbatim copying of this document is permitted, in any medium.

13.1 0. Preamble

Copyright law gives certain exclusive rights to the author of a work, including the rights to copy, modify and distribute the work (the "reproductive," "adaptative," and "distribution" rights).

The idea of "copyleft" is to willfully revoke the exclusivity of those rights under certain terms and conditions, so that anyone can copy and distribute the work or properly attributed derivative works, while all copies remain under the same terms and conditions as the original.

The intent of this license is to be a general "copyleft" that can be applied to any kind of work that has protection under copyright. This license states those certain conditions under which a work published under its terms may be copied, distributed, and modified.

Whereas "design science" is a strategy for the development of artifacts as a way to reform the environment (not people) and subsequently improve the universal standard of living, this Design Science License was written and deployed as a strategy for promoting the progress of science and art through reform of the environment.

13.2 1. Definitions

"License" shall mean this Design Science License. The License applies to any work which contains a notice placed by the work's copyright holder stating that it is published under the terms of this Design Science License.

"Work" shall mean such an aforementioned work. The License also applies to the output of the Work, only if said output constitutes a "derivative work" of the licensed Work as defined by copyright law.

"Object Form" shall mean an executable or performable form of the Work, being an embodiment of the Work in some tangible medium.

"Source Data" shall mean the origin of the Object Form, being the entire, machine-readable, preferred form of the Work for copying and for human modification (usually the language, encoding

or format in which composed or recorded by the Author); plus any accompanying files, scripts or other data necessary for installation, configuration or compilation of the Work.

(Examples of "Source Data" include, but are not limited to, the following: if the Work is an image file composed and edited in 'PNG' format, then the original PNG source file is the Source Data; if the Work is an MPEG 1.0 layer 3 digital audio recording made from a 'WAV' format audio file recording of an analog source, then the original WAV file is the Source Data; if the Work was composed as an unformatted plaintext file, then that file is the the Source Data; if the Work was composed in LaTeX, the LaTeX file(s) and any image files and/or custom macros necessary for compilation constitute the Source Data.)

"Author" shall mean the copyright holder(s) of the Work.

The individual licensees are referred to as "you."

13.3 2. Rights and copyright

The Work is copyright the Author. All rights to the Work are reserved by the Author, except as specifically described below. This License describes the terms and conditions under which the Author permits you to copy, distribute and modify copies of the Work.

In addition, you may refer to the Work, talk about it, and (as dictated by "fair use") quote from it, just as you would any copyrighted material under copyright law.

Your right to operate, perform, read or otherwise interpret and/or execute the Work is unrestricted; however, you do so at your own risk, because the Work comes WITHOUT ANY WARRANTY – see Section 7 ("NO WARRANTY") below.

13.4 3. Copying and distribution

Permission is granted to distribute, publish or otherwise present verbatim copies of the entire Source Data of the Work, in any medium, provided that full copyright notice and disclaimer of warranty, where applicable, is conspicuously published on all copies, and a copy of this License is distributed along with the Work.

Permission is granted to distribute, publish or otherwise present copies of the Object Form of the Work, in any medium, under the terms for distribution of Source Data above and also provided that one of the following additional conditions are met:

(a) The Source Data is included in the same distribution, distributed under the terms of this License; or

(b) A written offer is included with the distribution, valid for at least three years or for as long as the distribution is in print (whichever is longer), with a publicly-accessible address (such as a URL on the Internet) where, for a charge not greater than transportation and media costs, anyone may receive a copy of the Source Data of the Work distributed according to the section above; or

(c) A third party's written offer for obtaining the Source Data at no cost, as described in paragraph (b) above, is included with the distribution. This option is valid only if you are a non-commercial party, and only if you received the Object Form of the Work along with such an offer.

You may copy and distribute the Work either gratis or for a fee, and if desired, you may offer warranty protection for the Work.

The aggregation of the Work with other works which are not based on the Work – such as but not limited to inclusion in a publication, broadcast, compilation, or other media – does not bring the other works in the scope of the License; nor does such aggregation void the terms of the License for the Work.

13.5 4. Modification

Permission is granted to modify or sample from a copy of the Work, producing a derivative work, and to distribute the derivative work under the terms described in the section for distribution above, provided that the following terms are met:

- (a) The new, derivative work is published under the terms of this License.
- (b) The derivative work is given a new name, so that its name or title can not be confused with the Work, or with a version of the Work, in any way.
- (c) Appropriate authorship credit is given: for the differences between the Work and the new derivative work, authorship is attributed to you, while the material sampled or used from the Work remains attributed to the original Author; appropriate notice must be included with the new work indicating the nature and the dates of any modifications of the Work made by you.

13.6 5. No restrictions

You may not impose any further restrictions on the Work or any of its derivative works beyond those restrictions described in this License.

13.7 6. Acceptance

Copying, distributing or modifying the Work (including but not limited to sampling from the Work in a new work) indicates acceptance of these terms. If you do not follow the terms of this License, any rights granted to you by the License are null and void. The copying, distribution or modification of the Work outside of the terms described in this License is expressly prohibited by law.

If for any reason, conditions are imposed on you that forbid you to fulfill the conditions of this License, you may not copy, distribute or modify the Work at all.

If any part of this License is found to be in conflict with the law, that part shall be interpreted in its broadest meaning consistent with the law, and no other parts of the License shall be affected.

13.8 7. No warranty

THE WORK IS PROVIDED "AS IS," AND COMES WITH ABSOLUTELY NO WARRANTY, EXPRESS OR IMPLIED, TO THE EXTENT PERMITTED BY APPLICABLE LAW, INCLUDING BUT NOT LIMITED TO THE IMPLIED WARRANTIES OF MERCHANTABILITY OR FITNESS FOR A PARTICULAR PURPOSE.

13.9 8. Disclaimer of liability

IN NO EVENT SHALL THE AUTHOR OR CONTRIBUTORS BE LIABLE FOR ANY DIRECT, INDIRECT, INCIDENTAL, SPECIAL, EXEMPLARY, OR CONSEQUENTIAL DAMAGES (INCLUDING, BUT NOT LIMITED TO, PROCUREMENT OF SUBSTITUTE GOODS OR SERVICES; LOSS OF USE, DATA, OR PROFITS; OR BUSINESS INTERRUPTION) HOWEVER CAUSED AND ON ANY THEORY OF LIABILITY, WHETHER IN CONTRACT, STRICT LIABILITY, OR TORT (INCLUDING NEGLIGENCE OR OTHERWISE) ARISING IN ANY WAY OUT OF THE USE OF THIS WORK, EVEN IF ADVISED OF THE POSSIBILITY OF SUCH DAMAGE.

END OF TERMS AND CONDITIONS

[\$Id: dsl.txt,v 1.25 2000/03/14 13:14:14 m Exp m \$]

Index

- .end command, SPICE, 66
- Electronics Workbench*, 49
- Addition method, simultaneous equations, 33
- Adjacent, 39
- Algebraic identities, 23
- Ampacity, 18
- Analysis, AC, SPICE, 63
- Analysis, DC, SPICE, 63
- Analysis, Fourier, SPICE, 64, 74
- Analysis, transient, SPICE, 63
- Antiderivative of e functions, 47
- Antiderivatives, 46
- Arithmetic sequence, 27
- BASIC, computer language, 51
- C, computer language, 50
- Capacitance equation, 3
- Capacitors, SPICE, 57
- Common difference, 27
- Common ratio, 28
- Compiler, 51
- Component names, SPICE, 56
- Conductor ampacity, 18
- Constants, mathematical, 25
- Conversion factor, 8
- Cosines, law of, 40
- Critical temperature, superconductors, 20
- Current measurement, SPICE, 71
- Current sources, AC, SPICE, 62
- Current sources, DC, SPICE, 62
- Current sources, dependent, SPICE, 63
- Current sources, pulse, SPICE, 62
- Derivative of e functions, 44
- Derivative of a constant, 43
- Derivative of power and log functions, 44
- Derivative rules, 45
- Dielectric strength, 20
- Difference, common, 27
- Differential Equations, 48
- Diodes, SPICE, 58
- E, symbol for voltage, 1
- Factor, conversion, 8
- Factorial, 28
- Factoring, 26
- Fault, ground, 109
- FORTRAN, computer language, 50, 51
- Gage size, wire, 17
- General solution, 48
- Geometric sequence, 28
- Ground fault, 109
- Hyperbolic functions, 41
- Hypotenuse, 39
- I, symbol for current, 1
- Impedance, 5
- Independent variable, 48
- Inductance equation, 4
- Inductors, SPICE, 57
- Integral, definite, 48
- Integral, indefinite, 46
- Interpreter, 50
- Joule's Law, 1
- Law of cosines, 40
- Law of sines, 40
- Limits, calculus, 43
- Logarithm, 25
- Metric prefixes, SPICE, 56

- Metric system, 8
- Model, SPICE, 58
- Mutual inductance, SPICE, 57
- Netlist, SPICE, 51
- Nodes, SPICE, 54, 66
- Ohm's Law, 1
- Ohm's Law, AC, 6
- Open circuits, SPICE, 67
- Opposite, 39
- Option, *itl5*, SPICE, 65
- Option, *limpts*, SPICE, 65
- Option, *list*, SPICE, 65
- Option, *method*, SPICE, 65
- Option, *nopage*, SPICE, 65
- Option, *numdgt*, SPICE, 65
- Option, *width*, SPICE, 65
- Options, miscellaneous, SPICE, 65
- P, symbol for power, 1
- Parallel circuits, 2
- Particular solution, 48
- PASCAL, computer language, 51
- Periodic table, 129
- Plot output, SPICE, 64
- Power factor, 5
- Prefix, metric, 8
- Print output, SPICE, 64
- Programming, SPICE, 50
- Properties, arithmetic, 23
- Properties, exponents, 24
- Properties, radicals, 24
- Pythagorean Theorem, 40
- Quadratic formula, 27
- R, symbol for resistance, 1
- Radian, 41
- Ratio, common, 28
- Reactance, 5
- Resistance, specific, 19
- Resistance, temperature coefficient of, 19
- Resistor color codes, 13
- Resistors, SPICE, 57
- Resonance, 5
- Rules for antiderivatives, 47
- Scientific notation, SPICE, 56
- Semiconductor model, SPICE, 58
- Sequences, 27
- Series circuits, 2
- Simultaneous equations, 28
- Sines, law of, 40
- Slide rule, 26
- Specific resistance, 19
- SPICE, 49
- SPICE programming, 50
- SPICE2g6, 50
- Substitution method, simultaneous equations, 29
- Superconductivity, 20
- Systems of linear equations, 28
- Temperature coefficient of resistance, 19
- Temperature, critical, for superconductors, 20
- Time constant equations, 4
- Transform function, definition of, 26
- Transformers, SPICE, 57
- Transistors, bipolar, SPICE, 58
- Transistors, jfet, SPICE, 60
- Transistors, mosfet, SPICE, 60
- Trigonometric derivatives, 44
- Trigonometric equivalencies, 41
- Trigonometric identities, 39
- Troubleshooting, 101
- Unit, radian, 41
- Voltage sources, AC, SPICE, 61
- Voltage sources, DC, SPICE, 61
- Voltage sources, dependent, SPICE, 63
- Voltage sources, pulse, SPICE, 62
- Wetting current, 108
- Wire size, gage scale, 17